



# GPS 72

## *Personal Navigator*

owner's  
manual  
&  
reference  
guide

© Copyright 2000-2002  
GARMIN Ltd. or its subsidiaries  
All Rights Reserved

GARMIN International, Inc.  
1200 East 151<sup>st</sup> Street, Olathe, Kansas 66062 U.S.A.  
Tel. 913/397.8200  
Fax 913/397.8282

GARMIN (Europe) Ltd.  
Unit 5, The Quadrangle, Abbey Park Industrial Estate, Romsey, SO51 9AQ, U.K.  
Tel. 44/1794.519944  
Fax 44/1794.519222

GARMIN Corporation  
No. 68, Jangshu 2<sup>nd</sup> Road., Shijr, Taipei County, Taiwan  
Tel. 886/2.2642.8999  
Fax 886/2.2642.9099

Except as expressly provided herein, no part of this manual may be reproduced, copied, transmitted, disseminated, downloaded or stored in any storage medium, for any purpose without the express prior written consent of GARMIN. GARMIN hereby grants permission to download a single copy of this manual and of any revision to this manual onto a hard drive or other electronic storage medium to be viewed and to print one copy of this manual or of any revision hereto, provided that such electronic or printed copy of this manual or revision must contain the complete text of this copyright notice and provided further that any unauthorized commercial distribution of this manual or any revision hereto is strictly prohibited.

Information in this document is subject to change without notice. GARMIN reserves the right to change or improve its products and to make changes in the content without obligation to notify any person or organization of such changes or improvements.

Web Site address: [www.garmin.com](http://www.garmin.com)

GARMIN®, TracBack®, AutoLocate® are registered trademarks and MapSource™ is a trademark of GARMIN Corporation and may not be used without the express permission of GARMIN Corporation.

## **GPS 72 Registration**

**Help us better support you by completing your on-line registration today!**

Why should you register your GPS 72?

- Notification of New Products
- Lost or Stolen Unit Tracking

Connect to our Web Site ([www.garmin.com](http://www.garmin.com)) and look for the Product Registration link on the home page.

Thanks for choosing the GARMIN GPS 72. If you have any questions or comments regarding the use of the GPS 72 you can visit our Web Site or contact our Customer Service Department M-F, 8:00-5:00 CST (except holidays) at 1-800-800-1020.



---

*If you have previously registered a GARMIN product purchase using a mail-in registration card, we invite you to reregister that product using our NEW on-line system. Many services provided by our new product registration system are now being automated and reregistering your purchase ensures you the best possible support from GARMIN.*

---

## **Introduction**

### **Registration**



## Introduction

### Warnings and Cautions

**WARNING:** If you choose to use the GPS 72 in a vehicle, it is the sole responsibility of the owner/operator of the GPS 72 to secure the GPS unit so that it will not cause damage or personal injury in the event of an accident. Do not mount the GPS 72 over airbag panels or in a place where the driver or passengers are likely to have an impact with it in an accident or collision.

**WARNING:** If you choose to use the GPS 72 in a vehicle, it is the sole responsibility of the operator of the vehicle to operate the vehicle in a safe manner, maintain full surveillance of all driving conditions at all times, and never become distracted by the GPS 72 to the exclusion of safe operating practices. It is unsafe to operate the GPS 72 while you are driving. Failure by the operator of a vehicle equipped with an GPS 72 to pay full attention to operating the vehicle and road conditions while the vehicle is in motion could result in an accident or collision with property damage and personal injury.

**CAUTION:** IT IS THE USER'S RESPONSIBILITY TO USE THIS PRODUCT PRUDENTLY. THIS PRODUCT IS INTENDED TO BE USED ONLY AS A TRAVEL AID AND MUST NOT BE USED FOR ANY PURPOSE REQUIRING PRECISE MEASUREMENT OF DIRECTION, DISTANCE, LOCATION, OR TOPOGRAPHY.

**CAUTION:** The Global Positioning System (GPS) is operated by the government of the United States, which is solely responsible for its accuracy and maintenance. The system is subject to changes which could affect the accuracy and performance of all GPS equipment. Although the GPS 72 is a precision electronic NAVigation AID (NAVAID), any NAVIAID can be misused or misinterpreted and, therefore, become unsafe.

## **FCC Compliance**

The GPS 72 complies with Part 15 of the FCC interference limits for Class B digital devices FOR HOME OR OFFICE USE. These limits are designed to provide reasonable protection against harmful interference in a residential installation, and are more stringent than “outdoor” requirements.

Operation of this device is subject to the following conditions: (1) This device may not cause harmful interference, and (2) this device must accept any interference received, including interference that may cause undesired operation.

This equipment generates, uses and can radiate radio frequency energy and, if not installed and used in accordance with the instructions, may cause harmful interference to radio communications. However, there is no guarantee that interference will not occur in a particular installation. If this equipment does cause harmful interference to radio or television reception, which can be determined by turning the equipment off and on, the user is encouraged to try to correct the interference by one or more of the following measures:

- Reorient or relocate the receiving antenna.
- Increase the separation between the equipment and receiver.
- Connect the equipment into an outlet on a circuit different from that to which the receiver is connected.
- Consult the dealer or an experienced radio/TV technician for **help**.

The GPS 72 does not contain any user-serviceable parts. Repairs should only be made by an authorized GARMIN service center. Unauthorized repairs or modifications could result in permanent damage to the equipment, and void your warranty and your authority to operate this device under Part 15 regulations.

## **Introduction**

### **FCC Compliance Statement**



# Introduction

## Features



*NOTE: You should always be prepared and capable of navigating without the GPS 72. It is designed to complement other forms of basic navigation, not entirely replace them.*

The GPS 72 is a 7.5 ounce, 12 channel, hand held GPS receiver with a built-in Quad Helix antenna. The GPS 72 has nine keys located on the front of the unit, that allow the user to quickly access all of the units functions. The GPS 72 has a large 120 X 160 pixel, 4 level gray monochrome display for easy viewing.

The GPS 72 is a full function GPS with a factory-loaded marine point database. Using MapSource™, you can choose to have the GPS 72 display a variety of Points of Interest. Check your local dealer or our Web Site ([www.garmin.com](http://www.garmin.com)) for a complete listing of MapSource products.

GARMIN designed your GPS 72 with the user in mind. The GPS 72 is waterproof to IPX 7 standards, floats and is rugged enough to endure the most trying use. GARMIN's friendly user interface will allow you to be navigating with your GPS in no time. Your GPS 72 can provide one more critical benefit, peace of mind. With your GPS 72 you will know where you are, where you've been and where you're going. And since you'll always know the way back home, you can concentrate on what you set out to do, explore the great outdoors.

Thank you for choosing GARMIN!

### **Other features include:**

**Waypoints:** 500 with name and graphic symbol.

**Tracks:** Automatic Track Log; 10 saved Tracks.

**Routes:** 50 Routes that let you navigate through a set of 50 waypoints.

**Trip Computer:** Trip Odometer, Stopped Time, Moving Average Speed, Moving Time, Overall Average Speed, Total Time, Max Speed and Odometer.

**Tides:** Displays tide information graphically.

**Sun and Moon:** Sunrise, Sunset, Moonrise, Moonset, Position in Sky, and Moon Phase.

**Hunt and Fish:** Times

## Table of Contents

### **Introduction..... 1-7**

Registration .....	1
Warnings and Cautions .....	2
FCC Compliance Statement .....	3
Features.....	4
Table of Contents .....	5
“How To” Index.....	6
GPS 72 Unit Features .....	7

### **Section Two: Reference ..... 7-47**

Initializing the GPS Receiver.....	7-8
GPS Information Page .....	9-11
Map Page.....	12-17
Pointer Page .....	18
Highway Page.....	19-21
Main Menu Page.....	21-47
Trip Computer.....	21-22
Tracks.....	23-24
Waypoints .....	25
Creating Waypoints .....	26-28
Editing Waypoints .....	29
Points of Interest.....	30
Cities .....	30
Routes .....	31-34
Proximity.....	35
Goto Navigation .....	36-37
Celestial.....	38-40

MapSource Info .....	41
Setup Menu- General Tab .....	42-43
Setup Menu-Time Tab .....	43
Setup Menu-Units Tab .....	44
Setup Menu-Location Tab.....	44-45
Setup Menu-Alarms Tab .....	46
Setup Menu-Interface Tab.....	47

### **Appendices ..... 48-65**

Appendix A: Specifications .....	48
Appendix B: Wiring & Interfacing....	49
Appendix C: Time Offsets .....	50
Appendix D: Map Datums.....	51-52
Appendix E: Navigation Terms....	53-54
Appendix F: Messages .....	55-56
Appendix G: Loran TD.....	57-58
Appendix H: Accessories .....	59
Appendix I: Index .....	60-64
Appendix J: Warranty .....	65

# Introduction

## “How To” Index



The list to the right is provided to help you quickly find some of the more important procedures you will use on your new GPS 72.

<b>TO DO THIS:.....</b>	<b>SEE PAGE(S):</b>
Initialize the GPS receiver .....	7
Learn About the Map page .....	12-17
Zoom in or out on the Map page .....	12
Reconfigure the Map page display .....	12-17
Lear about the Pointer Page .....	18
Learn about the Highway Page .....	19-21
Setup and reset the Trip Computer .....	22
Clear the Track Log .....	23
Learn about waypoints .....	25
Create Waypoints .....	26-28
Edit Waypoints.....	41
Points of Interest .....	30
Create a route .....	31
Learn about the GOTO key .....	36
View celestial information .....	38-40
Change the displayed time (zone) .....	43
Change units of measure (statute, nautical, metric) .....	44
Set Alarms .....	46
View a unit message .....	55-56
Setup Loran TD .....	57-58



## Initializing the GPS Receiver

Before the GPS 72 can be used for navigation, the GPS receiver must be initialized. The GPS receiver should only need to be initialized the first time the unit is used, or if it has been stored several months.

The GPS 72 stores orbital data for each satellite in an Almanac. The orbital data is supplied in the satellite signals. Each time the unit is used, the Almanac is updated. This is how the GPS 72 knows which satellites to search for. If you do not use your GPS for several months, or move the unit several hundred miles between uses, the Almanac can become “cold”, that is to say that the orbital information is no longer valid. If the Almanac is “cold”, your unit may have trouble locking on to satellite signals. If the unit is unable to receive enough satellite signals to determine its location, it will display an options menu.

### **Initializing the GPS Receiver:**

1. With fresh batteries installed, take the unit outside where a clear 360° view of the sky can be obtained.
2. Turn the unit on and hold it in front of you with the top of the unit tilted upward. Follow the screen prompts, pressing **PAGE** to display the GPS Information Page.
3. The initialization process is automatic. It should take the GPS 72 no longer than five minutes to acquire enough satellite signals to become operational. When the unit is able to navigate, it will display either 2D GPS Location or 3D GPS Location in the Receiver Status Field.

## Reference

### Initializing the GPS Receiver

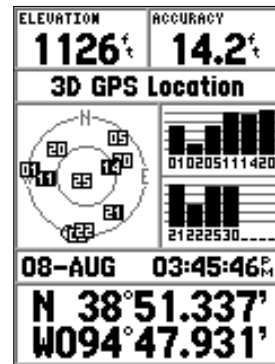

**Ready to Navigate**

## Reference

### Initializing the GPS Receiver



Initialization Options

### Initialization Options

If the GPS 72 is unable to determine its location, an options menu will be displayed. Depending on the situation, select an option to help the unit acquire satellites. To select an option, place the highlight over the option then press **ENTER**.

**Start Simulator** — The Simulator can be used when you are indoors and the GPS is unable to locate satellites. When you select 'Simulator', the GPS receiver is turned off saving battery power.

**New Location** — If you have moved the unit to another state, province, or country, and you are having trouble locking onto satellite signals select 'New Location'.

When you select 'New Location', another menu will be displayed. This menu contains the options 'Automatic' or 'Use Map'. If you select 'Automatic' the unit will switch to the AutoLocate mode and begin searching for satellites. If you select 'Use Map' you can use the Pointer on the Map Page to select your approximate location and the unit will continue to acquire satellites normally. 'Automatic' may take longer to acquire satellites.

**Stored w/o Batteries** — If you have stored the unit without batteries the date stored in the GPS may be incorrect. To check the date, highlight 'Stored w/o Batteries' and verify the date displayed. If the date is incorrect, select 'Stored w/o Batteries' to search for satellites.

**Continue Acquiring** — Select this option if you are in an area where the satellite signals are being temporarily blocked.

## GPS Information Page

The GPS Information Page displays your speed, elevation, the estimated accuracy, receiver status, satellite locations, satellite signal strength, the date, time and the GPS receiver's current location.

### Speed, Elevation and Estimated Accuracy

When the GPS is receiving at least three satellite signals, it will provide you with the current GPS Speed and the estimated Accuracy of the GPS Location. The GPS must be receiving at least four satellite signals to report the Elevation.

### Current GPS Receiver Status

The current status of the GPS receiver will always be displayed.

**Autolocate** — Forces the receiver to search for each satellite individually.

**Acquiring Satellites** — The receiver will be in this mode when the unit is turned on. The receiver will remain in this mode until it has acquired at least 3 satellite signals.

**2D GPS Location** — Indicates that the receiver is only using three satellite signals. When a 2D GPS Location is achieved, the GPS will display your current position but is incapable of providing an altitude reading.

**3D GPS Location** — Indicates the receiver is currently using at least four satellite signals and is capable of providing your current position and altitude.

**2D Differential Location** — Indicates the receiver is using DGPS or WAAS differential data on three satellites. A "D" will be displayed in or above the indicator bar for each differentially corrected satellite.

**3D Differential Location** — Indicates the receiver is using DGPS or WAAS differential data on at least four satellites. A "D" will be displayed in or above the indicator bar for each differentially corrected satellite.

**Lost Satellite Reception** — Indicates that the GPS receiver has lost satellite reception.

**Simulating GPS** — Indicates the GPS 72 is running in Simulator Mode and the GPS receiver is turned off. It is important to remember when you are using the Simulator, the GPS 72 can not be used for actual navigation.

## Reference

### GPS Information Page

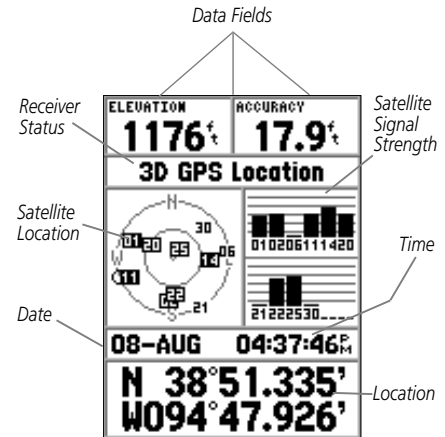

GPS Information Page

## Reference

### GPS Information Page

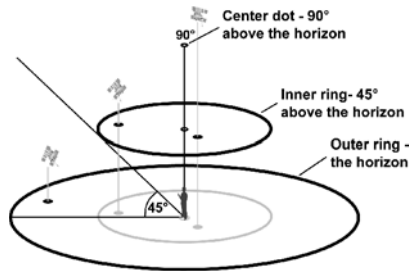

Satellite Sky View

### Satellite Location

The location of each available satellite is displayed over two location rings. The outer ring represents the horizon, the inner ring represents 45° above the horizon and the center represents directly overhead. When the unit is using a satellite for navigation, the satellite number will become highlighted on the location rings. The unit can be set to display satellite location with North, or your current track toward the top of the display.

### Satellite Strength Indicator Bars

The Satellite Strength Indicator Bars show the strength of the signal being received, and the status of the signal. The bars will be either shaded with a light grey, or filled with solid black. If the bar is grey, it means that the GPS is receiving a signal from the satellite and is in the process of storing orbital data provided in the GPS signal. When the bar turns solid black, the GPS is using the satellite signal for navigation. A "D" in or above the bar means that differential corrections are being applied to that satellite.

### Date, Time and Current Location

The GPS gets date and time information from the satellites. The satellites are equipped with an atomic clock that is very accurate. Since the GPS clock is derived from timing information sent from the satellite, the GPS clock is also very accurate.

When the GPS receiver has achieved a 2D or 3D GPS Location, the current location will be displayed in the selected Location Format. If you wish to see the current location in the default (hddd° mm.mmm) format, press the **ROCKER** up or down to toggle between the active and default format.

## GPS Information Page Options Menu

To activate the Options Menu, from the GPS Information Page press the **MENU** Key. To select an option, highlight the desired selection then press **ENTER**.

**Start/Stop Simulator** — This option is used to Start or Stop the Simulator.

**Track Up/North Up** — This option determines if the satellites are displayed with North toward the top of the display or your current track toward the top of the display.

**New Elevation** — This option can be used to enter a different elevation. If the GPS has a 2D GPS Location, entering a known elevation can increase the GPS accuracy.

**New Location** — If you have moved the unit to another state, province, or country, and you are having trouble locking onto satellite signals select 'New Location'.

When you select 'New Location', an options menu will be displayed. This menu contains the options 'Automatic' or 'Use Map'. If you select 'Automatic', the unit will switch to AutoLocate and begin searching for satellites. This method can take up to five minutes for the unit to begin navigation.

If you select 'Use Map', you can use the Pointer on the Map Page to select your approximate location and the unit will continue to acquire satellites normally using the almanac for satellite reference. Using this method, the unit does not need to reinitialize and should receive satellite signals quickly.

If the unit is in the 'Simulator' mode, the 'Use Map' feature will allow you to move the simulated current location.

## Reference

### GPS Information Page



GPS Information Page Options

## Reference

### Map Page

*User Selectable Data Fields*

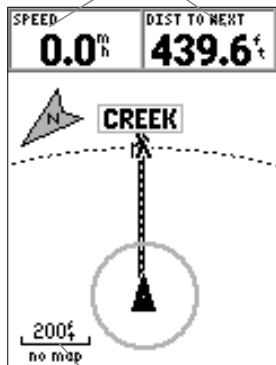

*Zoom Scale*

### Map Page

The GPS 72 comes with a factory-loaded marine point database that includes marine nav aids and major cities. This can be replaced with marine nav aids, cities, and points of interest using GARMIN MapSource products.

### Changing the Zoom Scale

You can change the Zoom Scale on the Map Page allowing you to view a smaller area in greater detail or a larger area with less detail. As referred to in this manual, when you decrease the Zoom Scale you will view a smaller area with greater detail. The current Zoom Scale setting is displayed in the lower left corner of the Map Page. If 'Overzoom' is displayed under the scale, no further map information is available.

#### **To change the Zoom Scale:**

1. Press the **IN** Key to decrease the Zoom Scale.
2. Press the **OUT** Key to increase the Zoom Scale.

### Map Page Options

To access the Map Page Options, with the Map Page displayed, press the **MENU** Key. To select an option from the Menu, highlight the desired selection then press **ENTER**.

**Full Screen Map** — This option hides the data fields and expands the map to include the entire display. When 'Full Screen Map' is selected the option will change to 'Show Data Fields'.

**Measure Distance** — This option will allow you to measure the distance between two points. As you move the Map Pointer, the Distance, Bearing and Location of the Pointer are displayed at the top of the map. To measure the distance between two map points, press **ENTER** to set a reference, then move the Map Pointer to the other location. The Bearing, and Distance are displayed below the data fields.

**Setup Page Layout** — This option allows you to select the number of data fields rows and the size of text used in the fields. You have the option of displaying Small (1 Row), Small (2 Rows), Small (3 Rows), Large (1 Row), or Large (2 Rows). To select an option, highlight the desired selection then press **ENTER**. The new configuration will be displayed on the map.

**Change Data Fields** — This option allow you to select the type of data that you want displayed in the data fields. To change a data type, place the highlight over the desired data field, then press **ENTER**. Using the **ROCKER**, scroll through the available selections. With the data type highlighted, press **ENTER** to accept the selection.

**Setup Map** — This option contains the Map Page Setup features. The features are arranged on a tab menu making it easy to locate the different setup items.

The 'Map', 'Waypoint', 'Point', and 'Line' Tabs have setting for 'Text', 'Zoom' or both. Please read the description of these settings to understand how they affect the display characteristics of the options on the Map Page.

- **Text Setting** — The 'Text' setting allows you to determine the size of text used when displaying a name or label for an item on the Map Page. There are four options for the 'Text' setting: Off, Small, Med, and Large. If you select 'Off', the item will be displayed on the map without a name or label. If you select 'Small', 'Med' or 'Large', the name, the item will be displayed with a name or label in the text size selected.

### Map Page Options



Map Page Options

## Reference

### Map Page Options



Setup Map — 'General' Tab

- **Zoom Setting** — This setting determines when items will be displayed on the map. You have the option of selecting 'Off', 'Auto' or a 'Zoom' Scale that coincides with the Zoom Scales for the map.

If you select 'Off', the items for that option will not be displayed on the Map Page. If you select 'Auto', the GPS 72 will automatically determine the zoom level at which to display the selected items. If you select a scale setting, the items will be displayed on the map only when the Map Zoom Scale is at or less than the selected scale .

As an example, if you select 500 ft as 'Zoom' Scale setting, the selected items will only be displayed when the Map Zoom Scale is at 500 ft or less.

#### **Setup Map — 'General' Tab**

The 'General' Tab contains the settings for Detail, Orientation and Auto Zoom. Below is a description of each feature. To change a setting, highlight the appropriate field then press **ENTER**. Make your selection, then press **ENTER** to accept the new selection.

**Detail** — Settings: Most, More, Normal, Less, and Least. The Detail settings allow you to control the amount of map data displayed on the unit. If you select a setting with high detail, the screen redraw times will be slower.

**Orientation** — Settings: North Up, Track Up, and Course Up. This option allows you to determine how the map is displayed. If 'North Up' is selected, North will always be at the top of the display. If 'Track Up' is selected, your current track will always be toward the top of the display. If 'Course Up' is selected, the active course line will always be toward the top of the display. If you have 'Course Up' selected and do not have an active course, your current track will be toward the top of the display.

**Auto Zoom** — This option allows you to have the map automatically zoom in on a waypoint as you approach it.



**Setup Map — ‘Map’ Tab**

The ‘Map’ Tab contains settings for the Basemap, MapSource, Lat Lon Grids, and Grid Labels. To change a setting, highlight the appropriate field then press **ENTER**. Make your new selection then press **ENTER** to accept the selection.

**MapSource** — This option allows you to turn map data displayed on the map ‘On’ or ‘Off’. This setting controls factory-loaded data as well as any MapSource data that may be loaded in the unit.

**Lat Lon Grid** — Lat Lon Grids will be displayed in smaller increments as the Zoom Level on the Map Page is decreased. The ‘Zoom’ setting for this option determines when the grids will begin displaying on the Map Page.

If you select ‘Auto’, and have the MapSource options set to ‘ON’, the unit will not display a Lat Lon Grid.

**Grid Labels** — This option allows you to display the coordinates on the grid.

You must have the ‘Lat Lon Grid’ displayed for ‘Grid Labels’ to be displayed. If you select ‘Auto’, and have the MapSource options set to ‘ON’, the unit will not display Grid Labels.

**Setup Map — ‘Waypoint’ Tab**

The ‘Waypoint Tab contains the Waypoints, and Active Route Waypoint option settings. Each of the options has a ‘Text’ and ‘Zoom’ setting. To change a setting, highlight the appropriate field then press **ENTER**. Make your new selection, then press **ENTER** to accept the selection.

**Waypoints** — This option sets the display parameters for all waypoints.

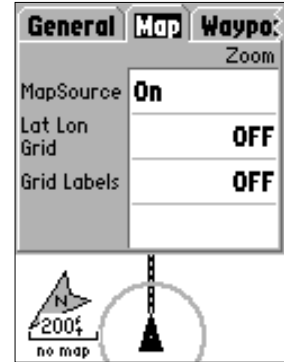
**Map Page Options****Setup Map — ‘Map’ Tab**

## Map Page Options

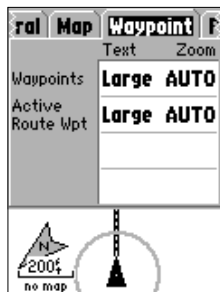

Setup Map — 'Waypoint' Tab

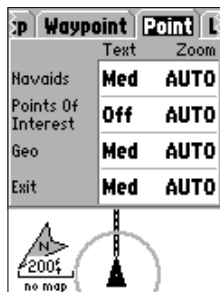

Setup Map — 'Point' Tab

**Active Route Waypoint** — This option sets the display parameters for waypoints that are in an Active Route. As an example, if you have selected 'Small' as the text option for all waypoints, but selected 'Large' as the setting for Active Route Waypoints, the waypoints included in an Active Route will be displayed with large text on the Map Page.

### Setup Map — 'Point' Tab

The 'Point' Tab contains the Nav aids, Points of Interest, Geo and Exit option settings. Each of the options has a 'Text' and 'Zoom' setting. To change a setting, highlight the appropriate field then press **ENTER**. Make your new selection, then press **ENTER** to accept the selection.

**Nav aids** — are items displayed on the Map that aid navigation. Nav aids can be landmarks, milemarkers, hazards, light houses, buoys, etc.

**Points of Interest** — include general business listings such as restaurants, hotels, gas stations, etc. Points of Interest are only available if MapSource data has been loaded in the unit.

**Geo** — include points such as schools, cemeteries, churches, towers, glaciers, parks, etc. Geo data is only available if MapSource data has been loaded in the unit.

**Exit** — information about exits that exist in MapSource data.

### Setup Map — 'Line' Tab

The 'Line' Tab contains the 'Zoom' scale settings for Track Log, Saved Tracks, Active Route, and an 'Off/On' setting for the Bearing Line. To change a setting, highlight the appropriate field then press **ENTER**. Make your new selection, then press **ENTER** to accept the selection.

**Track Log** — the Track Log is the bread crumb trail that is left behind as your position changes on the Map Page.

**Saved Tracks** — are Track Logs that have been saved in the units memory.

**Course Line** — controls the display of the Route Line and Go To Line.

**Bearing Line** — The Bearing Line will show the bearing from your current location to the active waypoint. This can be used to steer the shortest path to your waypoint.

### Setup Map — 'City' Tab

The 'City' Tab contains the 'Text' and 'Zoom' settings for Large City, Medium City, Small City and Small Towns. To change a setting, highlight the field then press **ENTER**. Make your selection, then press **ENTER** to accept.

The City settings are used to de-clutter the map. If 'Auto' is the selected 'Zoom' setting, the Large and Medium cities will be displayed at a higher Map Zoom Scale setting.

### Setup Map — 'Other' Tab

The 'Other' Tab contains the 'Text' and 'Zoom' settings for Railroad and an On/Off setting for the Accuracy Circle. To change a setting, highlight the appropriate field then press **ENTER**. Make your new selection, then press **ENTER** to accept the selection.

**Accuracy Circle** — The Accuracy Circle is displayed around the current location on the Map Page. The Accuracy Circle depicts the estimated accuracy of the location.

**Heading Line** — If the Heading line is 'On', a line showing your current heading will be projected on the map from the current location. The Heading line is a thin black line.

## Reference

### Map Page Options

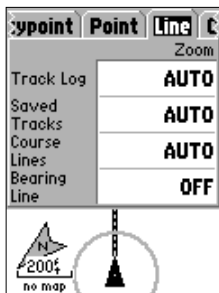

Setup Map — 'Line' Tab

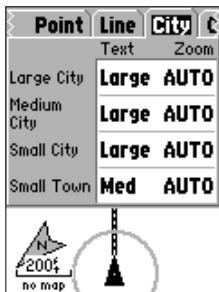

Setup Map — 'City' Tab

## Reference

### Pointer Page

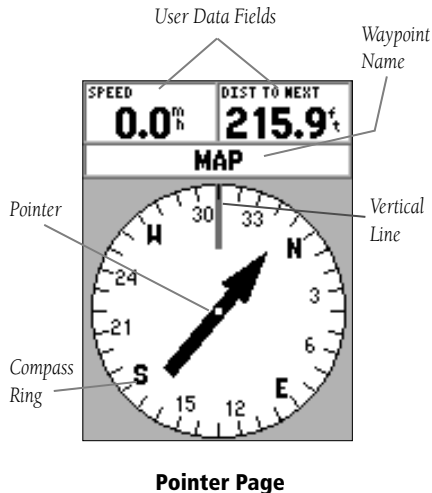

### Pointer Page

The Pointer Page is best used for navigation when a straight line course can not be followed. The Pointer Page has User Selectable Data Fields along the top, a Active Waypoint Field, Compass Ring and a Pointer.

The Compass Ring is a graphic display of your current track. As you change direction, the Compass Ring will rotate, aligning your track with the vertical line. As you change direction, the Pointer will always point toward the active waypoint. When you are going directly toward the active waypoint, the Pointer is aligned with the vertical line in the Compass Ring. When you arrive at the waypoint, a message 'Arriving at Destination' will be displayed. It is important to note that the Compass Ring does not act as a true compass. You must be moving for the Compass Ring and Pointer to update and provide accurate navigation.

### Pointer Page Options

To access the Pointer Page Options, from the Pointer Page, press the **MENU** Key.

**Setup Page Layout** — This option allows you to select the number of data field rows and the size of text used in the fields. You have the option of displaying None, Small (1 Row), Small (2 Rows), Small (3 Rows), Large (1 Row), or Large (2 Rows). To select an option, highlight the desired selection then press **ENTER**. The new configuration will be displayed on the map. Press **QUIT** to exit the option.

**Change Data Fields** — This option allow you to select the type of data that you want displayed in the data fields. To change a data type, place the highlight over the desired data field, then press **ENTER**. Using the **ROCKER**, scroll through the available selections. With the data type highlighted, press **ENTER** to accept the selection.

## Highway Page

The Highway Page is best used for navigation when a straight line course can be followed. The Highway Page has User Selectable Data Fields along the top, a Status Bar, and the Highway Display.

The Highway Page shares many features with the Map Page. Any tracks, saved tracks or waypoints that are within the display area will be shown, the Zoom Level can be changed using the **IN** and **OUT** keys, and the triangle represents your current location.

To navigate using the Highway, just follow the road. If the Highway moves to the right, turn right until the triangle is aligned with the White Line in the middle of the Highway, and the Highway is pointed toward the top of the display. When you are approaching a turn, the message “Approaching Turn” will be displayed. As you approach your destination, the message “Arriving at Destination” will be displayed.

### Highway Page Options

To access the Highway Page Options, with the Highway Page displayed press the **MENU** Key. To select an option from the Menu, highlight the desired selection then press **ENTER**.

**Setup Page Layout** — This option allows you to select the text size and the number of data fields rows. You have the option of displaying: None, Small (1 Row), Small (2 Rows), Small (3 Rows), Large (1 Row), or Large (2 Rows). To select an option, highlight the desired selection then press **ENTER**. The new configuration will be displayed on the map.

**Change Data Fields** — This option allows you to select the type of data you want displayed in the data fields. To change a data type, place the highlight over the desired data field, then press **ENTER**. Using the **ROCKER**, scroll through the available selections. With the data type highlighted, press **ENTER** to accept the selection.

## Reference

### Highway Page

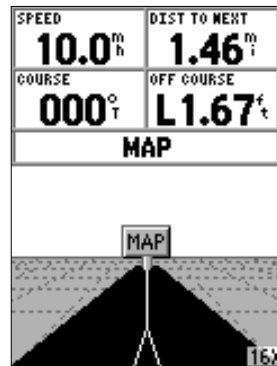

Highway Page

## Reference

### Highway Page



### Highway Page Options

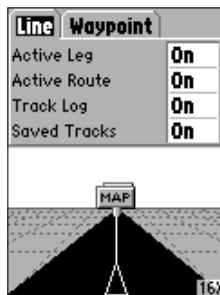

### Setup Highway Page

**Setup Highway** — This option contains the Highway Setup features. The features are arranged on a tab menu making it easy to locate the different setup items. To select an option from a Menu Tab, highlight the desired selection then press **ENTER**.

#### Setup Highway — 'Line' Tab

The 'Line' Tab contains the On/Off settings for Active Leg, Active Route, Track Log and Saved Tracks. To change a setting, highlight the appropriate field then press **ENTER**. Make your new selection, then press **ENTER** to accept the selection.

**Active Leg** — If 'Off' is selected, the Active Leg of the Graphic Highway will not be displayed.

**Active Route** — If 'Off' is selected, the Graphic Highway will not be displayed.

**Track Log** — If 'Off' is selected, the Track Log will not be displayed.

**Saved Tracks** — If 'Off' is selected, Saved Tracks will not be displayed.

#### Setup Highway — 'Waypoint' Tab

The 'Waypoint' Tab contains the On/Off settings for Next, Route, and Other. To change a setting, highlight the appropriate field then press **ENTER**. Make your new selection, then press **ENTER** to accept the selection.

**Next** — This setting determines if the next waypoint in a Route will be displayed. If 'On' is selected, you will see the next waypoint in the Route. If 'On' is selected and the Route option is set to 'Off', only the Next Waypoint in the Route will be displayed.

**Route** — This setting determines if the waypoints in a Route will be displayed. If this selection is set to 'Off', Route Waypoints will not be on the Graphic Highway.

**Other** — This setting determines if nearby waypoints are displayed.

## Main Menu Page

The Main Menu Page contains settings and features that are not on the Main Pages. The Main Menu can be accessed from any of the Main Pages by pressing **MENU** twice.

To select an item on the Main Menu, place the highlight over the menu item then press **ENTER**.

## Trip Computer

The Trip Computer has eight data fields: Trip Odom, Stopped Time, Moving Avg, Moving Time, Overall Avg, Total Time, Max Speed, and Odometer.

**Trip Odom** — The Trip Odometer field will display the total distance traveled since the Trip Computer was last reset.

**Stopped Time** — The Stopped Time field will display the total time that the unit was not moving since the Trip Computer was last reset.

**Moving Avg** — The Moving Average (Speed) field will display an average speed based on the time the unit was in motion since the Trip Computer was last reset.

**Moving Time** — The Moving Time field will display the total time the unit was in motion since the Trip Computer was last reset.

**Overall Avg** — The Overall Average (Speed) field will display the average speed of the unit since the Trip Computer was last reset.

## Reference

### Main Menu Page Trip Computer



Main Menu

## Reference

### Main Menu Trip Computer

Trip Computer	
Trip Odom	Stopped Time
0.45 <sup>m</sup>	21:46:29
Moving Avg	Moving Time
3.1 <sup>m</sup>	00:08:39
Overall Avg	Total Time
0.0 <sup>m</sup>	21:55:08
Max Speed	Odometer
22.6 <sup>m</sup>	0.45 <sup>m</sup>

Main Menu — Trip Computer

**Total Time** — The Total Time field will display the Total Time that the unit has been turned on since the Trip Computer was last reset.

**Max Speed** — The Maximum Speed field will display the maximum speed the unit traveled since the Max Speed was last reset.

**Odometer** — Will display the total distance traveled since it was last reset.

#### Trip Computer Options

To access the Trip Computer Options, with the Trip Computer displayed, press the **MENU** Key. To select an option, highlight the desired option then press **ENTER**.

**Reset Trip** — This option will reset all data fields except max speed and odometer to zero.

**Reset Max Speed** — This option will reset the Max Speed data field to zero.

**Reset Odometer** — This option will reset the Odometer data field to zero.



## Tracks

The Tracks Page displays the amount of Track Memory used, will allow you to 'Save' or 'Clear' the current Track Log, and displays a list of any Saved Tracks.

**Save** — When you select 'Save' you can choose how far back in the log you wish to save. Select the appropriate choice, press **ENTER** to save the selection.

**Clear** — The 'Clear' Button will allow you to clear the Track Log. If the Map Page is becoming cluttered from all of your tracks, clearing the Track Log will clean up the map.

### Track Page Options

To access the Track Options, with the Tracks Page displayed, press the **MENU** Key.

**Delete Saved Track** — If you have saved tracks, this option will allow you to delete the saved track.

**Delete All Tracks** — This option will delete all saved tracks.

**Setup Track Log** — This selection displays the Track Log Setup menu. This menu contains options for Track Recording, Record Method, and Interval.

- Record — 'Off', 'Wrap When Full' or 'Stop When Full'. If 'Wrap When Full' is selected, when track memory is full, the oldest track point will be deleted and a new point added at the end.
- Record Method — Can be set to 'Auto', 'Time' or 'Distance'.
- Interval — is used to select or enter an interval for the Record Method.

## Reference

### Main Menu Tracks

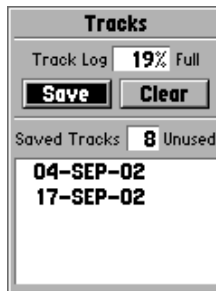

### Main Menu — Tracks Page

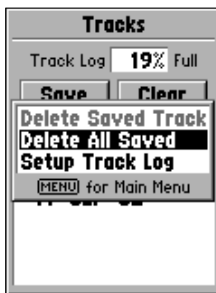

### Tracks Page Options

## Reference

### Main Menu Tracks

Track	
Name	
04-SEP-02	
Distance	Points
1.84 mi	107
Area	
1.057862 ac	
<input type="checkbox"/> Show on Map/Highway	
Delete	Map
TracBack	OK

Track Information Page

**TIP:**

If you know that you are going to want to use the TracBack feature for a return trip, clear the Track Log before you start the trip. This will ensure that you are only navigating along the most recent Track.

### Track Information Page

To access information on a Saved Track, highlight the desired track then press **ENTER**. This will display the Track Information Page.

The Track Information Page contains data fields for the Name, Distance, and Points. There are four Option Buttons along the bottom of the page.

**Name** — this field will allow you to change the Saved Track Name. When tracks are saved the GPS 72 will use a date as the default track name.

**Distance** — shows the total distance of the Saved Track.

**Points** — shows the number of track log points in the Saved Track.

**Area** — shows the area enclosed by the saved track. If the track crosses over itself, this value may be inaccurate.

**Show on Map and Highway** — when checked, will allow a Saved Track to be displayed on the Map and Highway Pages.

**Delete Button** — if the 'Delete' Button is selected, you will be prompted to verify you want to delete the Saved Track.

**TracBack Button** — will initiate TracBack Navigation. TracBack Navigation uses Track Points in a saved track to automatically create a route. You will have the option of navigating the route in the 'Original' or 'Reverse' direction.

**Map Button** — will display the Saved Track on the Map Page.

**OK Button** — saves any changes and returns the display to the Tracks Page.

## Points Page

The Points Page allow you to select Waypoints, Points of Interest, Cities, and Exits using your current location or a location on the map. To select a Point item, highlight the desired selection then press **ENTER**.

## Waypoints

When 'Waypoints' is selected, a user waypoint list will displayed. This list can be displayed as 'Waypoints by Name', or by 'Nearest Waypoints'. With the waypoint list displayed, pressing the **MENU** Key will display an Options Menu.

### Waypoint Options Menu

**Find By Name / Find Nearest** — This option allows you to select how the Waypoint List will be displayed.

**Find Nearest** — will display a list containing the nearest waypoints within a 100 mile radius. The waypoints will be listed with the nearest waypoint at the top of the list.

**Find By Name** — will display a list containing all User Waypoints. You have the option of entering a waypoint name in the data field or scrolling through the Waypoint List.

As you enter a waypoint name, the GPS 72 will update the waypoint list to show waypoint names that coincide with the letters that have been entered. You can continue to enter the name if you like, or you can press the **ENTER** Key and scroll through the list.

**Delete Waypoint** — Will delete the selected waypoint.

**Delete By Symbol** — Will delete all waypoints having the same symbol as the selected waypoint.

## Reference

### Main Menu Points Page



### Waypoint Option Menu

### Creating Waypoints



When creating a waypoint on the Map Page with the pointer on a Point of Interest, pressing **ENTER** will display an information page describing the feature. If you wish to create a waypoint, from the information page press **MENU** and with 'Save As Waypoint' selected press **ENTER**. The New Waypoint Page will be displayed where you can edit and save the waypoint.

### Creating Waypoints

There are three methods for creating waypoints in the GPS 72.

**Creating a waypoint using the ENTER/MARK Key** — When at a location that you want to save, press and hold **ENTER/MARK** until the Mark Waypoint Page is displayed. At this point you can edit the waypoint name, symbol, elevation and depth (see page 29 for information on editing waypoints). To save the waypoint to memory, highlight the 'OK' button and press **ENTER**.

**Creating a waypoint on the Map Page** — Using the **ROCKER**, move the Map Pointer to the location on the Map Page and press **ENTER/MARK**. If the Map Pointer is not on a Map Feature, the New Waypoint Page will be displayed. At this point you can edit the waypoint name, symbol, elevation and depth (see page 29 for information on editing waypoints). To save the waypoint to memory, highlight the 'OK' button and press **ENTER**.

**Creating a waypoint manually using existing coordinates** — Press and hold **ENTER/MARK** until the Mark Waypoint Page is displayed. The unit will capture its current location. Highlight the Location Field and press **ENTER**. Using the **ROCKER**, enter the new location. Press **ENTER** to accept the change. At this point you can edit the waypoint name, symbol, elevation and depth (see page 29 for information on editing waypoints). To save the waypoint to memory, highlight the 'OK' button and press **ENTER**.

## Create Waypoint Options Menu

There are four options available when creating waypoints. To view these options, press the **MENU** key while the Mark Waypoint page is displayed.

**Average Location** — When selected, the Average Waypoint page will be displayed. The page has fields for Location, Estimated Accuracy, Elevation and Measurement Count. While averaging, the unit will take a location reading approximately once a second. The readings are averaged and the estimated accuracy of the location is displayed. When the Estimated Accuracy has stabilized, press **ENTER** to return to the Mark Waypoint page where you can continue editing or save the waypoint.

**Project Location** — Selecting 'Project Location' allows you to change the location of the waypoint, to a location that is a set bearing and distance from a specified point. The Project Location page has four fields, 'Location', 'From', 'Distance' and 'Bearing'. There are three ways to establish a "From" reference point, you can use the current location, select a location on the map or use the location of an item found in the points menu. To select one of these options, highlight the 'From' field and press the **ENTER** key.

### Project Location Options

- **To project a waypoint from your 'Current Location'** — With 'Current Location' selected in the 'From' field, highlight the bearing or distance field and press **ENTER**. Enter a new bearing or distance and then press **ENTER** to accept the change. Do the same for the remaining field. When you have finished, highlight 'Save' and press **ENTER**. This will return you to the Mark Waypoint page. The waypoints location will have changed, reflecting the projected bearing and distance from your reference point. To save the waypoint, highlight 'OK' and press **ENTER**.

## Reference

### Creating Waypoints



Create Waypoint Options Menu

### Creating Waypoints



Append to Route List

- **'Use Map' to project a waypoint** — When 'Use Map' is selected, the unit will show a map page. Use the **ROCKER** to move the Map Pointer to the desired reference location and then press **ENTER**. On the Project Location page, enter a new bearing and distance. When you have finished, highlight 'Save' and press **ENTER**. This will return you to the Mark Waypoint page. The waypoints location will have changed, reflecting the projected bearing and distance from your reference point. To save the waypoint, highlight 'OK' and press **ENTER**.

- **'Use Points Menu' to project a waypoint** — When 'Use Points Menu' is selected, the unit will display the Points Menu. You can now select any point that is available from the waypoints list or any MapSource data that may be loaded in the unit. On the Project Location page, enter a new bearing and distance. When you have finished, highlight 'Save' and press **ENTER**. This will return you to the Mark Waypoint page. The waypoint's location will have changed, reflecting the projected bearing and distance from your reference point. To save the waypoint, highlight 'OK' and press **ENTER**.

**Delete Waypoint** — This option will delete the waypoint that is currently displayed. After selecting this option a conformation window will be displayed. With 'Yes' highlighted, press **ENTER** to delete the waypoint.

**Append to Route** — This option will add the new waypoint to an existing or new route.

- **Add waypoint to an existing route** — A list of existing routes will be displayed when 'Append to Route' is selected. Select the desired route from the list and press **ENTER**. The new route will be added to the end of the route.

- **Add waypoint to a 'New Route'** — When 'New Route' is selected, the waypoint will be added to a new route. The new route will be named using the waypoint names.

## Editing Waypoints

You can edit waypoints when they are created or after they have been saved to memory. There are six items that can be changed, the symbol, name, location, elevation, depth, you can choose whether or not to show the waypoint name on the Map Page.

**To edit a saved waypoint** — Press the **MENU** Key twice to display the Main Menu. Highlight 'Points' and press **ENTER**, then highlight 'Waypoints' and press **ENTER**. Select the desired waypoint (see page 25 for more information on the waypoint lists) and press **ENTER** to display the Waypoint Page. When finished, highlight the 'OK' button and press **ENTER** to accept the changes.

**Selecting a symbol** — Highlight the symbol field and press **ENTER**. Using the **ROCKER**, select a symbol from the list and press **ENTER**. The selected symbol will be displayed at the waypoint location on the Map Page.

**Changing the Location, Elevation or Depth** — Highlight the desired field and press **ENTER**. Using the **ROCKER**, scroll through the numeric list until the desired number is displayed. Press the **ROCKER** to the right to move to the next character. When finished, press **ENTER** to accept the changes.

**Show Name on Maps** — When 'Show Name on Maps' is checked, the waypoint name will be displayed on the Map Page. To check/uncheck the box, place the highlight over that box and press **ENTER**.

## Deleting Waypoints

To delete a single waypoint, highlight the waypoint on the waypoint list and press **MENU**. Select 'Delete Waypoint' and press **ENTER**. Select 'Yes' and press **ENTER** to delete the waypoint.

To delete a group of waypoints by their symbol, highlight a waypoint with the symbol that you want to delete and press **MENU**. Select 'Delete By Symbol' and press **ENTER**. Select 'Yes' then press **ENTER** to delete the waypoints.

To delete all waypoints, highlight a waypoint and press **MENU**. Select 'Delete All' and press **ENTER**. Select 'Yes' and press **ENTER** to delete the waypoints.

## Reference

### Editing Waypoints

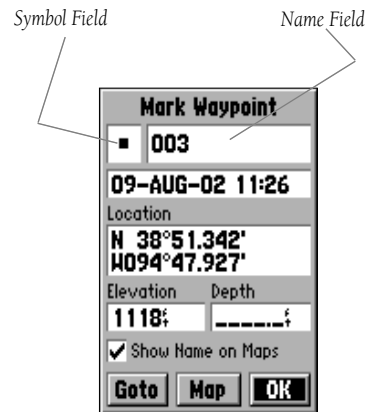

## Reference

### Main Menu Points Page

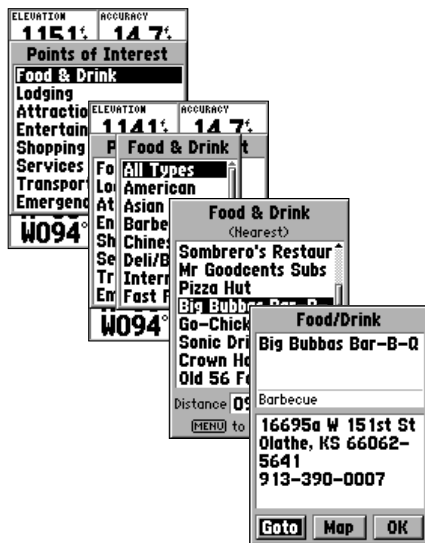

Main Menu — 'Points of Interest'

### Points of Interest

This option is only available when MapSource CD Points of Interest data is loaded in the unit. When 'Points of Interest' is selected, the Points of Interest Selection Page is displayed. To select an item, highlight the desired selection then press **ENTER**.

After an item is selected, either a list or selection menu will be displayed. If a selection menu is displayed, make another selection and press **ENTER**. When a list is displayed, pressing **MENU** will give you the option of searching the list by name or by showing the nearest item.

To view information about an item in the list, highlight the item then press **ENTER**. An Information window will be displayed showing the name, address and phone number of the item. To save the item as a waypoint, press the **MENU** Key and with 'Save as Waypoint' selected press **ENTER**.

Along the bottom of the list or Information Page are three buttons, Goto, Map and OK. 'Goto' begins direct navigation to the point, 'Map' displays the item on the Map Page and 'OK' returns the display to the list.

### Points of Interest Options

The types of Points of Interest displayed, depend on the MapSource data that is loaded.

### Cities

When 'Cities' is selected, a list of cities is displayed with the nearest city listed first. If you press **MENU**, you will have the option of finding a city by name or showing a list of the nearest cities.

To view information about a city on the list, highlight the city then press **ENTER**. An Information window will be displayed showing the city size (small, medium or large) the name and country of the city, and the bearing/distance of the city from your current location. To save the city as a waypoint, press **MENU**, with 'Save as Waypoint' selected press **ENTER**.



Along the bottom of the Information Page are three buttons, 'GoTo', 'Map' and 'OK'. 'GoTo' begins direct navigation to the point, 'Map' displays the city on the Map Page and 'OK' returns the display to the Cities List.

## **Routes**

A route is a series of waypoints used for point to point navigation. A route must have at least two waypoints, a start and finish, but can contain as many as fifty. The GPS 72 can store fifty routes.

On the Routes Page you can create 'New' routes, determine how many empty routes that you have left, and review a list of existing routes. To display the Routes Page, highlight 'Routes' on the Main Menu then press **ENTER**.

### **Routes Page Options**

With the Routes Page displayed, press **MENU** to view the available options.

**Start/Stop Navigation** — Will start navigation of a highlighted route. Will stop navigation of an Active Route.

**Copy Route** — Will make a copy of a highlighted route.

**Delete Route** — Will remove the highlighted route.

**Delete All Routes** — Will remove all routes from the Routes Page.

### **Creating a New Route**

There are several methods that can be used to create a route. To begin creating a new route, highlight the 'New' Button on the Routes Page then press **ENTER**. A blank Route Page will be displayed. To display the Create Route Options, press **MENU**. When you are creating a route, you should place the points in the route in the order that you wish to navigate them.

## **Main Menu Routes**



**Route Page Options**

## Reference

### Main Menu Routes



Create Route Options

### Create Route Options

**Use Map** — This displays the Map Page with the Map Pointer active. You can now point at any location or point on the map, and enter it into the route.

When using the Map to create a route, you can select an existing User Waypoint/Map Feature, or you can create a 'New' Waypoint. New Waypoints are created if you place the Map Pointer on a location that is not a Map Feature. A "New Waypoint" will be stored in the User Waypoint List and can be edited as any other User Waypoint. When placing a "New Waypoint" in a route, you will have to press **ENTER** to create the waypoint, **ENTER** to save the waypoint and **ENTER** a final time to insert it into the route.

If you place the Map Pointer on a Map Feature, the GPS 72 will only store that location in the route using the feature name as a reference. These points are not stored in the User Waypoint List. If you would like to save a Map Feature Point as a User Waypoint, highlight the point in the route, press **ENTER**, this will display an Information Page. With the Information Page displayed, press **MENU** and select 'Save as Waypoint'.

**Add Waypoint** — This will display the Points Menu (see page 28 for information on the Points Menu). As a note, if you highlight the dashed line in the waypoint field on the Route Page and press **ENTER** it is the same as making this selection. Use the Points Menu to display an Information Page, then highlight the 'OK' Button and press **ENTER**.

**Using a combination of the Map Page and Route Page** — You can create a route using a combination of the methods described above. Starting with a blank Route Page, either enter a waypoint manually or press the **MENU** Key and select 'Use Map'. You can select 'Use Map' at any time while creating a route. After you have finished using the map, press **QUIT** to display the Route Page where you can continue entering waypoints manually.

**Naming the Route** — the GPS 72 will automatically name the route using the first and last waypoint names as a reference. To change the Route Name, place the highlight over the Name field then press **ENTER**. When you have finished, press **ENTER** to save the new name.

### **Editing a Route**

To edit a route the unit must be on the Route Page. When editing a route you can Insert a Waypoint, Remove a Waypoint, Reverse the Route, Delete the Route or choose to edit the route on the Map Page. To display the Route Edit Options, press the **MENU** Key.

#### **Route Edit Options**

**Use Map** — This will display the Map Page with the Route Line active and the Map Pointer located on the waypoint highlighted on the Route Page. With the map displayed, press MENU to display the available options, Review, Remove, Move, and Next.

- **'Review' Route Waypoint** — To review information on a route waypoint, place the Map Pointer on the waypoint, then press **ENTER**. This will display an options menu. Highlight 'Review', then press **ENTER** to display the waypoint information.
- **Inserting a New waypoint** — There are two methods that can be used to insert a new waypoint into a route.

1. Place the Map Pointer on the route leg that you want to insert the new point in, and the line will turn to a small dashed line. Press **ENTER**, the Map Pointer will have "INS" under it. Move the Map Pointer, dragging the Route Line to the location that you want the new point at, then press **ENTER**. If the new location is a Map Feature, the point will be inserted in the leg. If the location is not on a Map Feature, the New Waypoint Page will be displayed. Press **ENTER** to save the new waypoint, then **ENTER** again to insert the new waypoint in the route.

### **Main Menu Routes**



**Route Edit Options**

## Reference

### Main Menu Routes

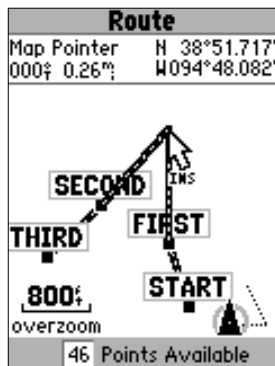

Inserting a waypoint on the Map Page

2. Place the Map Pointer over a location that is not a Map Feature then press **ENTER**. The New Waypoint Page will be displayed. Press **ENTER** to save the new waypoint. Place the Map Pointer over the route leg that you want to insert the waypoint into, then press **ENTER**.

- *Remove' a Point or Waypoint* — To remove a point or waypoint from the route, place the Map Pointer over the point or waypoint that you want to remove, then press **ENTER** to display an options menu. Highlight 'Remove' then press **ENTER**. The point or waypoint will be removed and the Map Pointer will move to the next point in the route.
- *'Move' a Waypoint* — Only User Waypoints can be moved. To move a waypoint, place the Map Pointer on the waypoint then press **ENTER**. This displays an options menu. Highlight 'Move' then press **ENTER**. Place the Map Pointer at the desired new location and press **ENTER** to move the waypoint. As a note, using this feature will change the stored waypoint's location
- *'Next' point in Route* — To move the Map Pointer to the next point in the route, with the Map Pointer on a route point or waypoint, press **ENTER**. This will display an options menu. Highlight 'Next', press **ENTER**, and the Map Pointer will move to the next point or waypoint in the route.

**Insert Waypoint** — When 'Insert Waypoint' is selected, the Points Menu is displayed. Select a point from the menu to insert it into the route. The new point will be inserted into the route above the waypoint highlighted on the Route Page.

**Remove Waypoint** — Will remove the waypoint that is highlighted on the Route Page. With a waypoint highlighted, press **MENU**. Highlight 'Yes' and press **ENTER** to remove the waypoint.

**Reverse Route** — Will reverse the direction of the route placing the last waypoint at the top of the list.

**Plan Route** — To plan a route, enter a Speed, Fuel Flow, Depart Time and Depart Date. Fuel Flow is measured in “units per hour”. It may be necessary to consult your vehicle’s Owner’s Manual for performance specifications.

The Active Route Page and Route Page display trip-planning information for each leg or the entire route. The information includes Course, ETA, Fuel to point, Leg Fuel, Leg Time, Sunrise & Sunset at point location, Time to Point and Leg Distance. To show a specific field, with the Active Route or Route Page displayed, press the **ROCKER** right or left to cycle through the fields.

**Delete Route** — Will remove the selected route from the Routes Page.

**Start/Stop Navigation** — Will begin or end navigation of the selected route

### **Proximity**

Proximity waypoints can be used to alert you when you are approaching a predetermined area. When you place a waypoint in the Proximity List, you will enter a ‘Radius’ that will determine when a Proximity Alarm will be displayed. You can turn the Proximity Alarm On or Off for your convenience.

#### **Proximity Options**

To view the available options with the Proximity Page displayed press **MENU**.

**Add Waypoint** — When ‘Add Waypoint’ is selected, the Points Menu is displayed (see page 24 for more information on the Points Menu). Select a point to insert into the Proximity List. With the ‘Radius’ field highlighted, press **ENTER**. Enter a radius for an alert to be displayed. You can also add a waypoint by highlighting the dashed entry line and pressing **ENTER**.

**Remove Point** — Removes the highlighted waypoint from the Proximity List.

**Remove All** — Removes all waypoints from the Proximity List.

### **Main Menu Proximity Alarm**

<b>Proximity</b>	
Alarm	
<b>On</b>	
Name	Radius
<b>ROCK</b>	<b>0.01<sup>m</sup></b>
<b>STUMP</b>	<b>0.03<sup>m</sup></b>
<b>001</b>	<b>0.30<sup>m</sup></b>
-----	----- <sup>m</sup>

**Proximity Alarm List**

## "Goto" Navigation

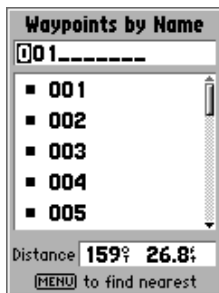

### Goto a Waypoint by Name

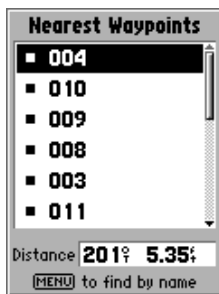

### List of Nearest Waypoints

## Navigating using the GOTO key

The GPS 72 uses waypoints to help you find your way. A waypoint is a location you create. You can create a waypoint using a selected location on the map, by entering coordinates, or by marking a location while actually there (see page 26 for information on creating waypoints).

Marine nav aids and city locations come preloaded in your GPS 72. These can be used just like waypoints, allowing you to navigate to these locations. Optional MapSource software allows you to add points of interest data that can also be used for navigation.

**Goto a waypoint** — Press and release the **GOTO** key. This displays the Go To Selection page. Highlight 'Waypoint' and press **ENTER**. A list of 'Waypoints by Name' will be displayed. You have the option of selecting a waypoint by spelling out its name or displaying a list of the nearest waypoints. To display the nearest list, press **MENU** and with 'Find Nearest' highlighted press **ENTER**.

- **Finding a waypoint by name** — If you have many waypoints in the list the easiest way to find a waypoint is to enter the waypoint name. As you spell the name, the GPS 72 will update the waypoint list showing the waypoints that closely match the spelling. When you see the waypoint on the list, press **ENTER**, and scroll through the list until the waypoint is highlighted. Press **ENTER** again to begin navigation.
- **Selecting a waypoint from the Nearest Waypoint list** — The Nearest Waypoint list will show the 15 nearest waypoints within 100 miles. To select a waypoint from the list, place the highlight over the desired waypoint, then press **ENTER** to begin navigation.

**Goto a Point** — Press and release the **GOTO** key. This displays the Go To Selection page. Depending on the optional MapSource data that may be loaded in the unit, Point of Interest, City, and Exit may be available.

- **Point of Interest** — Highlight ‘Point of Interest’ on the Go To Selection page and press **ENTER**. This will display a list of categories that are available. Select a category and press **ENTER**. A list of choices in that category will be displayed, select an item and press **ENTER**. Scroll through the displayed list, make a selection and press **ENTER** to begin navigation to that point.
- **City** — Highlight ‘City’ on the Go To Selection page and press **ENTER**. A list of Cities by Name will be displayed. Scroll through the displayed list, make a selection and press **ENTER** to begin navigation to that city.
- **Exit** — Highlight ‘Exit’ on the Go To Selection page and press **ENTER**. A category list will be displayed containing the selections All Types, Services, Rest Area or Other. Make a category selection and press **ENTER**. Scroll through the displayed list, make a selection and press **ENTER** to begin navigation to that Exit.

## “Goto” Navigation

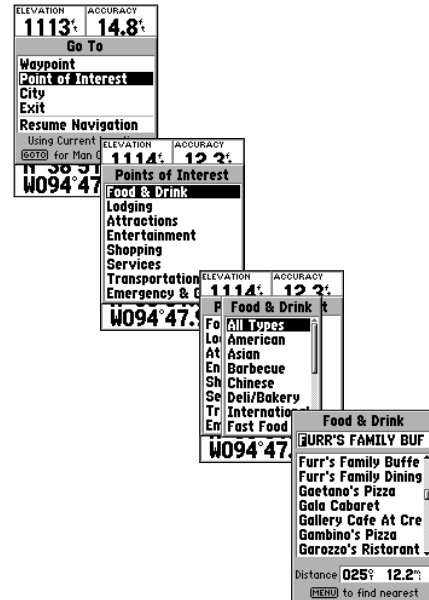

Goto a Point of Interest

## Reference

### Main Menu Celestial



Main Menu — Celestial

### Celestial

The Celestial Menu lets you view information for Tides, Sun and Moon, or Hunt and Fish.

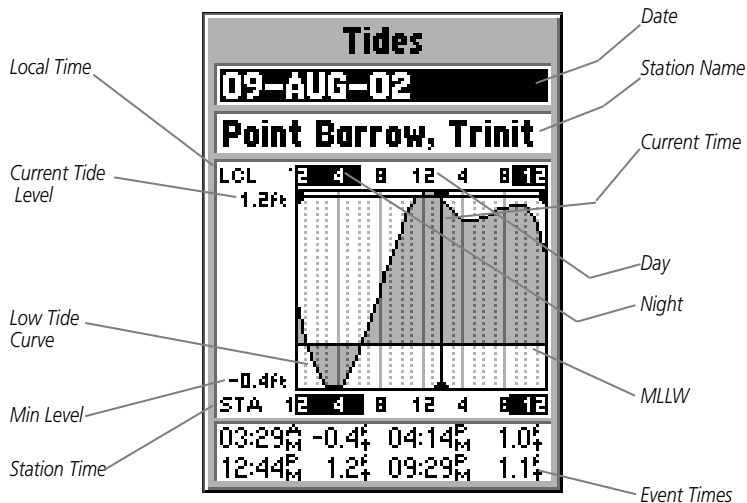

**Tides** — Displays a graphical chart which displays tide station information in a 24 hour span starting at midnight station time. You can choose from different dates and over 3000 tide stations around the USA coastline, Alaska, Hawaii, western Canada and several of the Caribbean Islands.



The top of the page will display the date with the tide station below. The top of the chart will show a 24-hour block of local time (LCL) for your position, with the reported station time (STA) appearing at the bottom. Daylight (light bar) and night (dark bar) will show across the time scale, with the time progressing from left to right. (Local time scales and sunrise/sunset info may not be available for a few stations). The solid, light vertical lines are in 4-hour increments, with the light, dotted vertical lined in 1-hour increments. A dark vertical line (with arrows at the ends of the line) will indicate the time of day when using current date and will intersect the tide graph to show their relation.

The tide curve will show as a shaded area, with higher tides being taller and lower tides shorter. The dark horizontal line (with arrows at the ends of the line) will indicate the current tide height. The figure to the left of the line will show the current tide level in feet. The Mean Lower Low Water (MLLW) will appear as a solid vertical line near the bottom of the chart (This line will only appear if the tide ranges to the zero value or below). The top and bottom numbers to the left of the chart, 'LCL and 'STA' indicate the maximum/minimum levels, respectively. The four data fields below the chart, indicate event times and levels at which the tide changes starting in the upper left field, going downward, then to the upper right and down again.

## Reference

### Main Menu Celestial — Tides

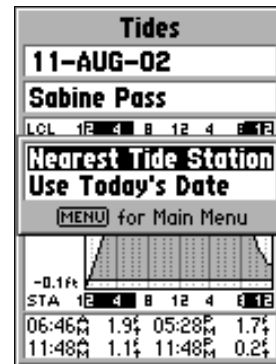

### Tide Page Options

## Reference

### Main Menu Celestial — Sun and Moon



Location Options

**Sun and Moon** — The Sun and Moon Page displays data for Sunrise/Sunset, Moonrise/Moonset, and the approximate location of the Sun and Moon on a skyview. The moon phase will display the current visible portion of the moon in a light shade. You may display this information for your current location or you can use the Map or Points Menu to select a location. To display the location options, press **ENTER** with Location field highlighted. You can also use the current date and time or enter a date and time of your choice.

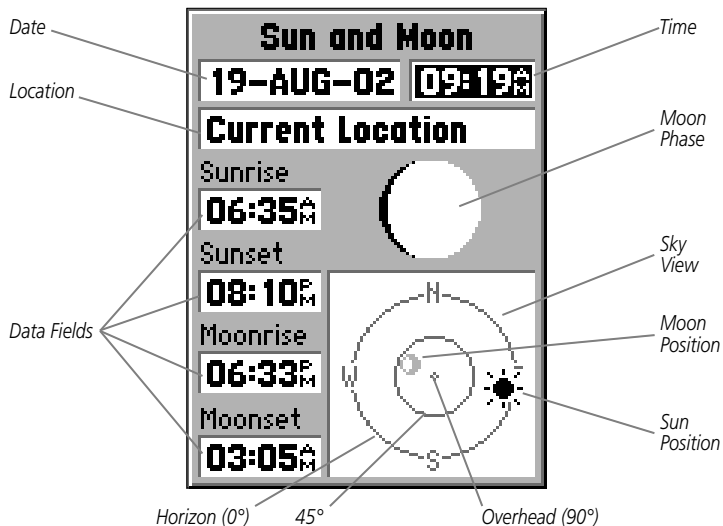

**Hunt and Fish** — The Hunt and Fish Page displays data for Good and Best times for hunting and fishing at the selected location. There is also a Rating (excellent, good, normal, poor) displayed, that will reflect the productivity of the day. You may display this information for your current location or you can use the Map or Points Menu to select a location. To display the location options, press **ENTER** with Location field highlighted. You can also use the current date and time or enter a date and time of your choice.

### **MapSource Info**

The MapSource Info Page displays a list of the MapSource data stored in the unit and description of the highlighted list item. You can choose to 'Show' the data on the map, by placing a checkmark in the 'Show' Box. To select/deselect a box, place the highlight over the MapSource Item then press **ENTER**. Pressing **MENU**, displays a list of "Show" options that allows you to choose 'Show All', 'Show None', or select from a list of map data that is loaded in the unit.

### **System Info**

The System Info Page will show your software version number and the unit ID number.

### **Setup Menu**

The Setup Menu is arranged in an easy to use tab format. Each tab (General, Time, Units, Location, Alarms, Interface) contains the settings that will determine how the unit functions. To select a tab, the highlight must be on the tab name then use the **ROCKER** Key (right/left) to scroll through the tabs. To select a data field on a tab, use the **ROCKER** Key (up/down) to highlight the selection then press **ENTER**. To restore the setting on a selected tab to the factory settings, press **MENU** and with 'Restore Defaults' highlighted press **ENTER**.

## Reference

### Main Menu

<b>Hunt and Fish</b>	
<b>09-AUG-02</b>	
<b>Current Location</b>	
Rating	
<b>Good</b>	
Best Times	
<b>12:41<sup>AM</sup></b>	<b>02:41<sup>AM</sup></b>
<b>01:00<sup>PM</sup></b>	<b>03:00<sup>PM</sup></b>
Good Times	
<b>06:52<sup>AM</sup></b>	<b>07:52<sup>AM</sup></b>
<b>07:11<sup>PM</sup></b>	<b>08:11<sup>PM</sup></b>

### Hunt and Fish Page

<b>MapSource Info</b>	
Gulf Coast, Aug 2002	
Show Map Name	
<input checked="" type="checkbox"/>	<b>Gulf Coast, Ame</b>
Americas Tides and Marine Services v4.00; Gulf Coast, Americas Tides and M	

### MapSource Info Page

## Reference

### Main Menu General Tab



Setup Menu — 'General' Tab

### Setup Menu — 'General' Tab

The 'General' Tab contains settings for the Receiver Mode, WAAS, Backlight Time Out, Beeper, and Language. To change a setting, highlight the field then press **ENTER**. Make your selection then press **ENTER** to activate the selection.

**Mode** — The Mode selections are 'Normal', 'Battery Saver' and 'Simulator'.

*'Normal'* — This is the default mode set from the factory. Use this setting for best performance.

*'Battery Saver'* — When 'Battery Saver' is selected, the receiver is optimized to save battery power. You may experience slower screen updates, but should notice a significant increase in battery life. While in Battery Saver mode, the unit will not receive WAAS satellite signals.

*'Simulator'* — When in 'Simulator' mode the GPS receiver is turned off and the unit simulates satellite reception. Use the Simulator mode when the unit is indoors and you wish to practice with the unit.

**'WAAS'** — WAAS is an acronym for "Wide Area Augmentation System". You can use the WAAS capability of the GPS 72 to increase the accuracy to approximately 3 meters. When enabled the GPS receiver searches for a WAAS satellite, then receives data that will help correct differentials in the GPS signal. When the unit is using WAAS data, a "D" will be displayed in the Satellite Strength Indicators on the GPS Information Page, and the receiver status will indicate a 2D or 3D Differential Location.

Currently the WAAS system is not fully operational. There are two WAAS satellites in place, one over the Pacific Ocean and one over the Atlantic Ocean. You must have a clear unobstructed view of the sky to receive a WAAS signal, even then, at times it may not be possible to receive a WAAS signal.

For more information on the WAAS system visit the Federal Aviation Administration Web Site at ([gps.faa.gov](http://gps.faa.gov)).

**'Backlight Timeout'** — Sets the time that the Backlight will remain on once activated. The options are 'Stays On', '15 Seconds', '30 Seconds', '1 Minute' and '2 Minutes'.

**'Beeper'** — This setting determines when the Beeper is used. The options are 'Key and Message', 'Message Only', and 'Off'.

**'Language'** — Select from seven languages, English, German, French, Italian, Spanish, Swedish, and Norwegian.

### Setup Menu — 'Time' Tab

The 'Time' Tab contains settings for Time Format, Time Zone, Daylight Savings Time, Current Date, and Current Time. To change a setting, highlight the field then press **ENTER**. Make your selection then press **ENTER** to activate the selection.

**'Time Format'** — The GPS 72 can display time in a 12 or 24 hour format.

**'Time Zone'** — The 'Time Zone' setting has nine options, Atlantic, Eastern, Central, Mountain, Pacific, Alaska, Hawaii, Samoa, and Other. If you choose 'Other' a new field "UTC Offset" will be displayed. Enter the correct offset for your Time Zone. You can find a chart with UTC Offsets in Appendix C.

**'Daylight Savings Time'** — Has three options, 'Yes', 'No', and 'Auto'. If you select 'Auto', the unit will automatically determine when Daylight Savings Time should be displayed. If you select 'Yes', Daylight Savings Time for the current location will be displayed. If you select 'No', Daylight Savings Time will not be displayed. If you have 'Other' selected in the 'Time Zone' field, this option will not be available and Daylight Savings Time will be off.

**'Current Date'** — Shows current date that is determined by the unit.

**'Current Time'** — This field shows the time at the current location. This field reflects any settings in the 'Daylight Savings Time' field, and is not accessible by the user.

### Main Menu Time Tab



### Setup Menu — 'Time' Tab

## Reference

### Main Menu Units & Location Tabs

hddd.ddddd°	India Zone IVA
hddd°.mm.mmm'	India Zone IVB
hddd°.mm'ss.s"	Irish Grid
British Grid	LORAN TD
Dutch Grid	Maidenhead
Finnish Grid	MGRS
German Grid	New Zealand
India Zone 0	QNG Grid
India Zone IA	RT 90
India Zone IB	Swedish Grid
India Zone IIA	Swiss Grid
India Zone IIB	Taiwan Grid
India Zone IIIA	UTM UPS
India Zone IIIB	W Malayan RSO
	User UTM Grid

#### User UTM Grid

*The 'User UTM Grid' will let the user define a grid format. The user will have to know the Longitude Origin, Scale, False Easting, and False Northing to create the grid.*

*For more information on grids and datums, we recommend that you visit the National Imagery and Mapping Agency at <http://www.nima.mil>*

### Setup Menu — 'Units' Tab

The 'Units' Tab contains settings for Elevation, Depth, Distance and Speed, Temperature, Direction Display, and Speed Filter. These settings are used in related fields throughout the unit.

**'Elevation'** — Can be set to show in 'Feet' or 'Meters'.

**'Depth'** — Can be set to display in 'Feet', 'Fathoms' and 'Meters'. The GPS 72 cannot measure depth on its own. The depth input has to come from a NMEA device providing the "DPT" or "DBT" sentence.

**'Distance and Speed'** — Can be set to 'Nautical', 'Statute' or 'Metric'.

**'Temperature'** — Can be set to 'Fahrenheit' or 'Celsius'.

**'Direction Display'** — Can be set to 'Numeric Degrees', 'Cardinal Letters' or 'Mils'. The setting will be used in all fields that relate to direction.

**'Speed Filter'** — Can be set to 'Auto' or a 'User' defined setting. If 'User' is selected, a Seconds field will be displayed. To enter a 'User' defined setting, highlight the Seconds field then press **ENTER**. When finished, press **ENTER** to save the entry. When using a 'User' defined setting, the unit will average the speed and heading at the rate specified in the time setting.

### Setup Menu — 'Location' Tab

The 'Location' Tab contains the settings for 'Location Format', 'Map Datum', 'North Reference' and 'Magnetic Variation'. The settings are used in fields throughout the unit.

**'Location Format'** — There are 29 different formats to choose from. See the sidebar for a list of the formats. You should not need to change the format from the default setting unless you are using a chart or paper map for navigation. If so, select the format that matches your chart or map.

**'Map Datum'** — Datums are used to describe geographic positions for surveying, mapping, and navigation and are not actual maps built in the unit. Although there are over 100 datums available to choose from, you should only need to change the Map Datum if you using a chart or paper map that specifies a different datum in the legend. See Appendix D for a list of Map Datums.



**WARNING:** *Selecting the wrong map datum can result in substantial position errors. When in doubt, use the default WGS 84 datum for best overall performance.*

**'North Reference'** — Let's you select the reference used in calculating heading information. You can select 'Auto' 'True', 'Magnetic', 'Grid' or 'User'. 'Auto' provides magnetic north heading references which are automatically determined from your current location. 'True' provides headings based upon a true north reference. 'Grid' provides headings based on a grid north reference. 'User' allows you to specify the magnetic variation at your current location, and provides magnetic north heading references based on the value you entered.



**WARNING:** *If 'User' is selected, you must periodically update the magnetic variation at your present position. Failure to update this setting may result in substantial differences between the information displayed on your unit and external references, such as a magnetic compass.*

**'Magnetic Variation'** — displays the magnetic variation at your current location. If 'User' is selected for the 'North Reference', this field is used to enter the magnetic variance.

## Main Menu Location Tab

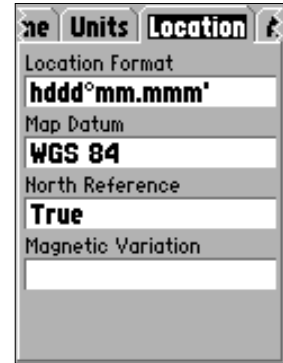

Setup Menu — 'Location' Tab

## Reference

### Main Menu Alarms Tab

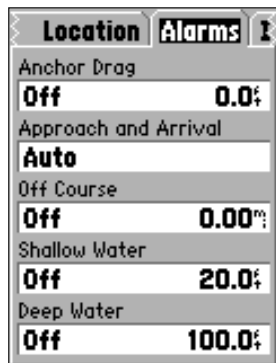

Setup Menu — 'Alarms' Tab

### Setup Menu — 'Alarms' Tab

The 'Alarms' Tab contains settings for Anchor Drag, Approach and Arrival, Off Course, Shallow Water, and Deep Water. These settings will determine if, and when a warning beep is sounded and/or a message is displayed.

**'Anchor Drag'** — The Anchor Drag Alarm alerts you when the boat has drifted more than a distance set by the user. The alarm can be turned 'On' or 'Off'.

**'Approach and Arrival'** — The Approach and Arrival Alarms alert you when you are approaching a turn or arriving at your destination. 'Automatic' will alert you between 15 and 90 seconds before, depending on your speed. 'Distance' and 'Time' alert you at the specified distance or time.

**'Off Course'** — The Off Course Alarm will alert you when you are off course more than the distance set. The Off Course alarm can be turned 'On' or 'Off'.

**'Shallow Water'** — This alarm requires input from a NMEA device supplying the "DPT" sentence. The Shallow Water alarm will alert you when the water depth is less than the depth set.

**'Deep Water'** — This alarm requires input from a NMEA device supplying the "DPT" sentence. The Deep Water Alarm will alert you when the water is deeper than the depth set.



## Setup Menu — 'Interface' Tab

The Interface Tab contains one field, 'Serial Data Format'. This field contains eight settings that allow the GPS 72 to communicate with computer software and other electronic devices.

- **GARMIN** — Allows the GPS 72 to communicate with GARMIN software and other GARMIN GPS units.
- **GARMIN DGPS** — Allows the GPS 72 to communicate with GARMIN Differential Correction devices. The unit can have the beacon receiver scan for an available DGPS beacon or can tune the beacon receiver to the frequency and bit rate of a nearby DGPS beacon.
- **NMEA** — Causes the unit to transmit NMEA 0183, version 2.3 data. It also allows the GPS 72 to accept NMEA data from another NMEA device, like a echo sounder. The baud (speed of communication in bits per second) is displayed in the Baud field.
- **Text Out** — Allows the GPS 72 to output simple text data that includes, date, time, position, and velocity information. The Baud can be set to 1200, 2400, 4800, or 9600 bps.
- **RTCM In** — Allows the GPS 72 to accept DGPS information from a device supplying RTCM data in a SC-104 format. The Baud can be set to 1200, 2400, 4800, or 9600 bps.
- **RTCM In/NMEA Out** — Functions the same as the 'GARMIN DGPS' setting except, the unit will output NMEA 0183, version 2.3 sentences, GPRMC, GPGLL, GPGGA, GPGSA, GPGSV, GPGLL, GPBOD, GPRTE, and GPWPL.
- **RTCM In/Text Out** — The same as the 'RTCM In' setting except, the unit will output simple text data that includes date, time, position, and velocity information. The Baud can be set to 1200, 2400, 4800, or 9600 bps.
- **None** — Turns off all serial communication.

## Reference

### Main Menu Setup Menu — Interface Tab

When any NMEA output is selected, the NMEA data transmission can be customized to keep the update rate at two seconds. With an NMEA output selected, press MENU and select 'Setup NMEA Output' to show the setup window. You can set the precision of the location, control how waypoints are identified, and enable/disable selected NMEA sentences. To change a setting, highlight the field and press **ENTER**. Make your selection, press ENTER again to accept the selection. To check/uncheck a box, highlight the box and press ENTER.

**NMEA Output Setup**  
Lat/Lon Minutes Precision  
**XX.XXXX** (4 digits)  
Waypoint Identifiers  
**Names**  
Enabled Sentences  
 GPS Status (GSA, GSV)  
 Wpt/Route (WPL, RTE)  
 GARMIN Proprietary

#### NMEA Sentence Output (NMEA 2.3 compliant)

Always transmitted: GPRMC, GPGGA, GPGL, GPBWC, GPVTG, GPXTE, GPRMB

Switchable: GPGSA, GPGSV, GPWPL, GPRTE

Garmin proprietary: PGRME, PGRMZ, PGRMM

# Appendix A

## Specifications

### Physical Specifications

Size:	1.2" x 2.7" x 6.2" (3.0cm x 6.9cm x 15.75cm)
Weight:	7.5 oz (.21kg)
Display:	High-contrast FSTN, 4-level gray scale display (120 x 160 pixels)
Case:	Fully gasketed, floatable, high-impact plastic alloy, waterproof to IEC 529-IPX-7
Temp. Range:	5°F to 158°F (-15°C to 70°C)

### Performance

Battery Life:	16 Hours in Battery Saver Mode
Receiver:	Differential-ready 12 parallel channel receiver
Acquisition Times:	Approx. 15 seconds (warm start) Approx. 45 seconds (cold start) Approx. 5 minutes (First Time/AutoLocate™)
Update Rate:	1/second, continuous
GPS Accuracy:	* < 15 meters (49 feet) RMS 95% typical
DGPS (USCG) Accuracy:	3-5 meters (10-16 ft), 95% typical
DGPS (WAAS) Accuracy:	3 meters (10ft) 95% typical with DGPS corrections
Velocity Accuracy:	0.1 knot RMS steady state
Dynamics:	6g's

\* Subject to accuracy degradation to 100m 2DRMS under the U.S. DOD-imposed Selective Availability Program.

### Power

Batteries:	Two 1.5-volt AA batteries <sup>1</sup>
Source:	8-35V DC
Fuse:	AGC/3AG - 2.0 Amp

<sup>1</sup>The temperature rating for the GPS 72 may exceed the usable range of some batteries. Alkaline batteries can rupture at high temperatures. Alkaline batteries lose a significant amount of their capacity as temperature decreases. Use lithium batteries when operating the GPS 72 in below-freezing conditions. Extensive use of screen backlighting will significantly reduce battery life.

## Connecting the Power/Data

The power/data cable connects the GPS 72 to a 8-35 volt DC system and provides interface capabilities for connecting external devices. The color code in the diagram below indicates the appropriate harness connections. Replacement fuse is a AGC/3AG - 2.0 Amp fuse.

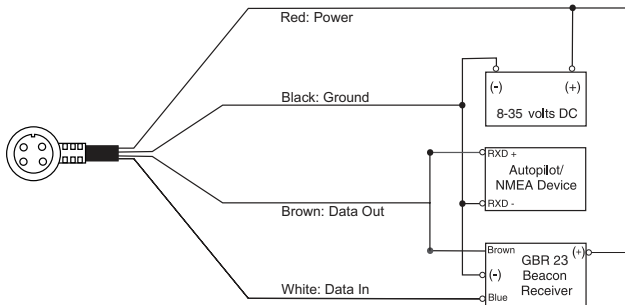

## Interfacing

The following formats are supported for connection of external devices:

GARMIN proprietary Differential GPS (DGPS), NMEA 0183 version 2.3, ASCII Text Output, RTCM SC-104 input (version 2.0).

The following are the sentences for NMEA 0183, version 2.3 output:

Approved sentences — GPRMC, GPGGA, GPGSA, GPGSV, GPGLL, GPBOD, GPRTE, and GPWPL; Proprietary sentences — PGRME, PGRMZ, and PSLIB. The GPS 72 also includes NMEA input with support for the DPT, MTW, and VHW sentences.

You can download a copy of GARMIN's proprietary communication protocol on the Help and Support section of our Web Site at [www.garmin.com](http://www.garmin.com).

## Appendix B

### Wiring and Interfacing

#### Unit View

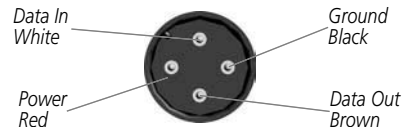

#### Cable View

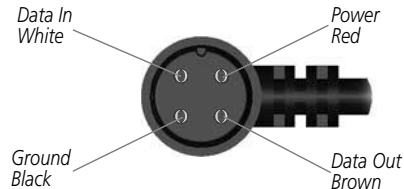

## Appendix C

The chart below gives an approximate UTC (Universal Time Coordinate) time offset for the various longitudinal zones. Check with local charts for more detailed information. If you are in daylight savings time, add one hour to the offset.

### Time Offsets

Longitudinal Zone	Offset	Longitudinal Zone	Offset
W180.0° to W172.5°	-12	E007.5° to E022.5°	+1
W172.5° to W157.5°	-11	E022.5° to E037.5°	+2
W157.5° to W142.5°	-10	E037.5° to E052.5°	+3
W142.5° to W127.5°	-9	E052.5° to E067.5°	+4
W127.5° to W112.5°	-8	E067.5° to E082.5°	+5
W112.5° to W097.5°	-7	E082.5° to E097.5°	+6
W097.5° to W082.5°	-6	E097.5° to E112.5°	+7
W082.5° to W067.5°	-5	E112.5° to E127.5°	+8
W067.5° to W052.5°	-4	E127.5° to E142.5°	+9
W052.5° to W037.5°	-3	E142.5° to E157.5°	+10
W037.5° to W022.5°	-2	E157.5° to E172.5°	+11
W022.5° to W007.5°	-1	E172.5° to E180.0°	+12
W007.5° to E007.5°	0		

Adindan	Adindan- Ethiopia, Mali, Senegal, Sudan
Afgooye	Afgooye- Somalia
AIN EL ABD '70	AIN EL ANBD 1970- Bahrain Island, Saudi Arabia
Anna 1 Ast '65	Anna 1 Astro '65- Cocos I.
ARC 1950	ARC 1950- Botswana, Lesotho, Malawi, Swaziland, Zaire, Zambia RC 1960 Kenya, Tanzania
Ascnsn Isld '58	Ascension Island '58- Ascension Island
Astro B4 Sorol	Sorol Atoll- Tern Island
Astro Bcn "E"	Astro Beacon "E"- Iwo Jima
Astro Dos 71/4	Astro Dos 71/4- St. Helena
Astr Stn '52	Astronomic Stn '52- Marcus Island
Aus Geod '66	Australian Geod '66- Australia, Tasmania Island
Aus Geod '84	Australian Geod '84- Australia, Tasmania Island
Austria	Austria
Bellevue (IGN)	Efate and Erromango Islands
Bermuda 1957	Bermuda 1957- Bermuda Islands
Bogata Observ	Bogata Observatory - Colombia
Campo Inchspe	Campo Inchauspe- Argentina
Canton Ast '66	Canton Astro 1966- Phoenix Islands
Cape	Cape- South Africa
Cape Canavrl	Cape Canaveral- Florida, Bahama Islands
Carthage	Carthage- Tunisia
CH-1903	CH 1903- Switzerland
Chatham 1971	Chatham 1971- Chatham Island (New Zealand)
Chua Astro	Chua Astro- Paraguay
Corrego Alegre	Corrego Alegre- Brazil
Croatia	Croatia
Djakarta	Djakarta (Batavia)- Sumatra Island (Indonesia)
Dos 1968	Dos 1968- Gizo Island (New Georgia Islands)
Dutch	Dutch
Easter Isld 67	Easter Island 1967
European 1950	European 1950- Austria, Belgium, Denmark, Finland, France, Germany, Gibraltar, Greece, Italy, Luxembourg, Netherlands, Norway, Portugal, Spain, Sweden, Switzerland
European 1979	European 1979- Austria, Finland, Netherlands, Norway, Spain,

## Appendix D

### Map Datums

Finland Hayfrd	Sweden, Switzerland
Gandajika Base	Finland Hayford- Finland
GDA	Gandajika Base- Republic of Maldives
Geod Datm '49	Geocentric Datum of Australia
Guam 1963	Geodetic Datum '49-New Zealand
Gux 1 Astro	Guam 1963- Guam Island
Hjorsey 1955	Guadalcanal Island
Hong Kong '63	Hjorsey 1955- Iceland
Hu-Tzu-Shan	Hong Kong
Indian Bngldsh	Taiwan
Indian Thailand	Indian- Bangladesh, India, Nepal
Indonesia 74	Indian- Thailand, Vietnam
Ireland 1965	Indonesia 1974-Indonesia
ISTS 073 Astro	Ireland 1965- Ireland
Johnston Island	ISTS 073 ASTRO '69- Diego Garcia
Kandawala	Johnston Island NAD27 Central
Kerguelen Islnd	Kandawala- Sri Lanka
Kertau 1948	Kerguelen Island
L. C. 5 Astro	West Malaysia, Singapore
Liberia 1964	Cayman Brac Island
Luzon Mindanao	Liberia 1964- Liberia
Luzon Philippine	Luzon- Mindanao Island
Mahe 1971	Luzon- Philippines (excluding Mindanao Isl.)
Marco Astro	Mahe 1971- Mahe Island
Massawa	Marco Astro- Salvage Isl.
	Massawa- Eritrea (Ethiopia)

# Appendix D

## Map Datums

Merchich	Merchich- Morocco
Midway Ast '61	Midway Astro '61- Midway
Minna	Minna- Nigeria
NAD27 Alaska	North American 1927- Alaska
NAD27 Bahamas	North American 1927- Bahamas
NAD27 Canada	North American 1927- Canada and Newfoundland
NAD27 Canal Zone	North Am. 1927- Canal Zone
NAD27 Caribbn	North American 1927- Caribbean (Barbados, Caicos Islands, Cuba, Dom. Rep., Grd. Cayman, Jamaica, Leeward and Turks Islands)
NAD27 Central	North American 1927-Central America (Belize, Costa Rica, El Salvador, Guatemala, Honduras, Nicaragua)
NAD27 CONUS	North Am. 1927- Mean Value (CONUS)
NAD27 Cuba	North American 1927- Cuba
NAD27 Grnland	North American 1927- Greenland (Hayes Peninsula)
NAD27 Mexico	N. American 1927- Mexico
NAD27 San Sal	North American 1927- San Salvador Island
NAD83	North American 1983- Alaska, Canada, Central America, CONUS, Mexico
Nhrwn Masirah	Nahrwn- Masirah Island (Oman)
Nhrwn Saudi A	Nahrwn- Saudi Arabia
Nhrwn United A	Nahrwn- United Arab Emirates
Naparima BWI	Naparima BWI- Trinidad and Tobago
Obsrvtorio '66	Observatorio 1966- Corvo and Flores Islands (Azores)
Old Egyptian	Old Egyptian- Egypt
Old Hawaiian	Old Hawaiian- Mean Value

Oman	Oman- Oman
Ord Srvy GB	Old Survey Grt Britn- England, Isle of Man, Scotland, Shetland Isl., Wales
Pico De Las Nv	Canary Islands
Potsdam	Potsdam-Germany
Ptcairn Ast '67	Pitcairn Astro '67- Pitcairn
Prov S Am '56	Prov So Amrcn '56- Bolivia, Chile, Colombia, Ecuador, Guyana, Peru, Venezuela
Prov S Chln '63	So Chilean '63- S. Chile
Puerto Rico	Puerto Rico & Virgin Isl.
Qatar National-	Qatar South Greenland
Qornoq	Qornog-South Greenland
Reunion	Reunion- Mascarene Island
Rome 1940	Rome 1940- Sardinia Isl.
RT 90	Sweden
Santo (Dos)	Santo (Dos)- Espirito Santo
Sao Braz	Sao Braz- Sao Miguel, Santa Maria Islands
Sapper Hill '43	Sapper Hill 1943- East Falkland Island
Schwarzeck	Schwarzeck- Namibia
Sth Amrcn '69	S. American '69- Argentina, Bolivia, Brazil, Chile, Colombia, Ecuador, Guyana, Paraguay, Peru, Venezuela, Trin/Tobago
South Asia	South Asia- Singapore
SE Base	Southeast Base- Porto Santo and Madiera Islands
SW Base	Southwest Base- Faial, Graciosa, Pico, Sao Jorge and Terceira
Taiwan	Taiwan
Timbalai 1948	Timbalai 1948- Brunei and E. Malaysia (Sarawak and Sabah)
Tokyo	Tokyo- Japan, Korea, Okinawa
User	User-defined custom datum
Tristan Ast '68	Tristan Astro 1968- Tristan da Cunha
Viti Levu 1916	Viti Levu 1916- Viti Levu/Fiji Islands
Wake-Eniwetok	Wake-Eniwetok- Marshall
WGS 72	World Geodetic System 72
WGS 84	World Geodetic System 84
Zanderij	Zanderij- Surinam (excluding San Salvador Island)

### Navigation Terms

**Avg Speed**— The average of all second-by-second speed readings since last reset.

**Bearing (BRG)**— The compass direction from your current location to a destination.

**Course**— The desired course between the active 'from' and 'to' waypoints.

**Distance (Dist)**— The 'great circle' distance from current location to a destination.

**Dist to Dest**— The 'great circle' distance from current location to a GOTO destination, or the final waypoint in a route.

**Dist to Next**— The 'great circle' distance from current location to a GOTO destination, or the next waypoint in a route.

**Elevation**— Height above mean sea level (MSL).

**ETA**— Estimated Time of Arrival. The estimated time you will reach your destination waypoint, based on current speed and track.

**ETA at Dest**— The estimated time you will reach a GOTO destination, or the final waypoint in a route.

**ETA at Next**— The estimated time you will reach a GOTO destination, or the next waypoint in a route.

**Fuel**— The fuel required to travel from current location to the indicated route waypoint.

**Leg Dist**— The distance between two route waypoints.

**Leg Fuel**— The fuel required to travel from a route waypoint to the next waypoint (in sequence) in the route.

**Leg Time**— The time required to travel from a route waypoint to the next waypoint (in sequence) in the route.

**Max Speed**— The maximum second-by-second speed recorded since last reset.

**Moving Average Speed**— Average speed while the unit is moving.

**Moving Trip Timer**— Total time the unit has been moving.

## Appendix E

### Navigation Terms

**Odometer**— A running tally of distance travelled, based upon the distance between second-by-second position readings.

**Off Course**— The distance you are off a desired course in either direction, left or right. Also referred to as ‘cross-track error’ or ‘course error’.

**Speed**— The current velocity at which you are travelling, relative to a ground position. Also referred to as ‘ground speed’.

**Time To**— The estimated time required to reach a GOTO destination, or the next waypoint in a route. Also referred to as ‘estimated time en route’.

**Time to Dest**— The estimated time required to reach a GOTO destination, or the final waypoint in a route.

**Time to Next**— The estimated time required to reach a GOTO destination, or the next waypoint in a route.

**To Course**— The recommended direction to steer in order to reduce course error or stay on course. Provides the most efficient heading to get back to the desired course and proceed along your route.

**Track**— The direction of movement relative to a ground position. Also referred to as ‘ground track’.

**Trip Odometer**— A running tally of distance travelled since last reset. Also see ‘Odometer’.

**Total Average Speed**— Average speed of unit for both moving and stopped speeds since last timer reset.

**Total Trip Timer**— Total time the unit has been in operation since last reset of the trip timers.

**Turn**— The angle difference between the bearing to your destination and your current track. ‘L’ indicates you should turn left, ‘R’ indicates you should turn right. The degrees indicate the angle you are off course.

**VMG**— Velocity Made Good. The speed you are closing in on a destination along a desired course. Also referred to as the ‘vector velocity’ to your destination.



### Messages

**Approaching Turn** — is displayed when you are nearing a turn in a route.

**Arriving at Destination** — is displayed when you are nearing your destination.

**Batteries Low** — when displayed you have less than 10 minutes of battery left.

**Cannot display all found, use city** — The unit found too many items to display. Narrow the search using the city.

**Deep Water** — The water is deeper than the amount set in the Deep Water Alarm.

**Database Error** — Internal problem with the unit. Contact your dealer or GARMIN Customer Service to have the unit repaired.

**Dragging Anchor** — is the message displayed when the distance set in the Anchor Alarm is exceeded.

**Lost Satellite Reception** — The unit is unable to continue receiving satellite signals.

**Memory Full** — Unit memory is full, no further data can be saved.

**Near Proximity Point** — You have reached the distance set for a proximity waypoint

**No Diff GPS Location** — RTCM is selected but the unit is not receiving DGPS data.

**None Found** — No data matched the search criteria.

**No Tide Stations for that Area** — No tide stations within 100 miles of the area.

**Off Course** — You are off course the distance set in the 'Off Course' Alarm.

**Proximity Memory Full** — No additional proximity waypoints can be saved.

**Proximity Radius Overlaps** — The radius of two proximity waypoints overlap.

**Route Already Exists** — You have entered a route name that already exists.

**Route Memory Full** — No additional routes can be saved.

**Route Truncated** — Uploaded route from another device has more than 50 waypoints.

**Route Waypoint Memory Full** — No additional route waypoints can be saved.

## Appendix F

### Messages

**Shallow Water** — The water is shallower than the amount set in the Shallow Water Alarm.

**Track Already Exists** — A saved track with the same name already exists.

**Track Memory Full** — No more data can be stored without deleting old data.

**Track Log Full** — Indicates the track log is full and track recording has been turned off. To be able to record more track points you will need to clear the track log and turn track recording on. This will only be displayed when the track recording setting is set to ‘Stop When Full’.

**Track Truncated** — A complete uploaded track will not fit in memory. The oldest track log points have been deleted.

**Can't Unlock Maps** — No applicable unlock code for one or more maps was found. All MapSource map are not accessible.

**Waypoint Already Exists** — A waypoint with the same name already exists.

**Waypoint Memory Full** — The unit has stored the maximum number of waypoints.

**Transfer Complete** — Data transfer has been completed.

### Loran TD

#### **Loran TD System**

LORAN C is a radio navigation aid operated and maintained in the United States by the United States Coast Guard. The name LORAN is an acronym for “LOng RANge Navigation”. The LORAN system covers the entire United States and the U.S. Coastal Confluence Zone. From the perspective of a mariner, the system is used for ocean and coastal navigation. It can be used as a supplemental system for harbor and harbor approach navigation, and it is used for inland navigation by recreational vehicles.

#### **LORAN TD Feature**

The LORAN TD (Time Delay) feature eases the transition from using LORAN to using GPS. The GPSMAP unit automatically converts GPS coordinates to LORAN TDs for those who have a collection of LORAN fixes for favorite fishing spots and other waypoints recorded as TDs. You can display your position as a TD or enter waypoints as TDs. The accuracy to be expected from this conversion is approximately thirty meters. When the unit is placed in the LORAN TD format mode, it simulates the operation of a LORAN receiver. Position coordinates may be displayed as TDs, and all navigation functions may be used as if the unit was actually receiving LORAN signals.

#### **Using the LORAN TD Format**

When creating new waypoints using LORAN TD coordinates, you must set the correct LORAN chain number and secondary stations in the Setup TD field before storing the waypoint. After the waypoint is stored in unit memory, it will always reference the LORAN chain number and secondary stations currently selected in the Setup TD field. If you enter a different LORAN chain number, change the secondary stations or offsets in the Setup TD field, the active waypoint information will reflect those changes. Since the GPS 72 does not rely on the LORAN signal for navigation, it can reference a different GRI chain and/or secondary stations and still navigate to the location stored in memory.

## Appendix G

### Loran TD

The LORAN Position Format field is located under the Units tab in the Main Menu. The 'LORAN TD Setup' window contains the fields to select the Loran GRI-Chain Number, Primary and Secondary Stations, and TD Offsets.

#### To setup Loran TD from the Main Menu:

1. Using the **ROCKER**, highlight the "Location Format" field on the 'Location Tab" and press **ENTER**.
2. Highlight 'Loran TD', press **ENTER**.
3. To change the settings of any of the five fields, highlight the field, press **ENTER** select/enter the desired setting then press **ENTER**.
4. When done, press the **PAGE** Key to return to the Main Menu.

If the active GRI Chain, secondary stations or offsets have been changed since the waypoint was created, the waypoint will now reference the active GRI-chain and secondary stations and adjust the TD coordinates accordingly. Remember that the GPS is not relying on the LORAN signal for navigation and actually converts the TD coordinate to a useful LAT/LON coordinate before storing the waypoint to memory or using it for navigation. Because of this the unit can navigate to a TD coordinate anywhere in the world.

## **Standard Accessories**

Owner's Manual  
Quick Reference Guide  
Lanyard

*Provides convenient method for carrying the GPS 72.*

## **Optional Accessories**

Automotive Mounting Bracket

*Requires the Marine Mount. This kit includes the mounting base, temporary and permanent adhesive pads and a new swivel bracket.*

Marine Mount

*The bracket can rotate 360° and tilt more than 45° backward or forward.*

Carrying Case

*Protects the GPS 72 when not in use.*

Power/Data Cable

*Wiring harness can be used to hardwire the unit to auxiliary power and to interface with other NMEA devices.*

PC Data Cable

*Allows for serial data transfer with a PC.*

Cigarette Lighter Adapter

*Allows the GPS 72 to operate from external auto power.*

MapSource™ Map Data CD-ROMs

*Enhance the Map Data, create waypoints and routes from your PC.*

## **Appendix F**

### **Accessories**



**Marine Mount**



**Automotive Mount**



**PC Cable**

# Appendix I

## Index

<b>A</b>	
Accessories .....	59
Accuracy .....	9
Accuracy Circle .....	17
Active Leg .....	20
Active Route .....	20
Active Route Page.....	35
Alarms Tab .....	46
Anchor Drag Alarm .....	46
Append to Route .....	28
Approach and Arrival Alarm.....	46
Autolocate.....	9
Average Location .....	27
<b>B</b>	
Backlight Timeout .....	43
Bearing/Distance Measuring .....	12
Bearing Line .....	17
Battery Life .....	48
Batteries Low Message.....	55

Battery Saver Mode .....	42
Bearing Line .....	17
Beeper .....	43

## C

Cautions.....	2
Celestial Page .....	38
Changing Data Fields .....	13,18,20
Cities.....	30
Course Line .....	17
Clearing the Track Log .....	23
Creating Waypoints.....	26
Current Date .....	43
Current Location.....	10
Current Time .....	43
Customer Service .....	65

## D

Data Transfer .....	47
Date .....	10
Daylight Savings Time .....	43
Deep Water Alarm .....	46
Delete Waypoint .....	28
Deleting Waypoints .....	29
Depth .....	44
DGPS Interface Settings.....	47
DGPS Status.....	9
Direction Display .....	44
Distance and Speed .....	44

## Index

<b>E</b>	
Editing a Route .....	33
Editing Waypoints .....	29
Elevation .....	44
Estimated Accuracy .....	9
ETA (Estimated Time of Arrival).....	53

<b>F</b>	
Features.....	4
Follow Track (TrackBack).....	24
Full Screen Map .....	12

<b>G</b>	
Go To a Waypoint .....	36
GPS Accuracy .....	48
GPS Information Page .....	9
GPS Information Page Options.....	11
Grid (Map Page) .....	15
Grid Labels.....	15

<b>H</b>	
Heading (North Reference).....	45
Heading Line .....	17
Highway Page .....	19
Highway Page Setup.....	20
“How To” Index.....	6
Hunt and Fish .....	41

<b>I</b>	
IN Key.....	12
Initialize the Receiver .....	7
Interface Tab .....	47
Interfacing .....	49

<b>L</b>	
Language .....	43
Local Time Offset .....	43
Limited Warranty .....	65
Location Format .....	44
Location Tab .....	44
Loran TD Setup .....	57, 58

<b>M</b>	
Main Menu.....	22-47
Magnetic Variation .....	45
MapSource Info .....	41
Map Datums .....	45, 51, 52
Map Page .....	12

# Appendix I

## Index

Map Page Options .....	12
Map Page Setup .....	13
Map Scales .....	12
Map Zooming .....	12
Measure Distance .....	12
Messages .....	55, 56
Mode .....	42
Moon Phase .....	40
Moorise/Moonset .....	40
<b>N</b>	
Nav aids .....	16
Navigation Terms .....	53, 54
Nearest Tide Station .....	39
Nearest Waypoint List .....	25, 36
New Location .....	8
New Route .....	31
NMEA Output Formats .....	47
NMEA Sentence Output .....	47
North Reference .....	45

## O

Odometer, Trip .....	22
Off Course Alarm .....	46
Orientation .....	14
Overzoom .....	12

## P

Plan Route .....	35
Pointer Page .....	18
Pointer Page Options .....	18
Points of Interest .....	16, 30
Power/Data Cable .....	49
Project Location .....	27
Proximity Alarm .....	35
Proximity List .....	35
Proximity Waypoints .....	35

## R

Receiver Status .....	9
Registration .....	1
Reviewing Waypoints .....	29
Reset Max Speed .....	22
Reset Odometer .....	22
Reset Trip .....	22
Reverse Route .....	34
Routes .....	31-35
Route Page .....	31
Route Page Options .....	31



Route - Creating .....	31-32
Route - Editing.....	33-34
Route - Planning.....	35
RTCM .....	47

## S

Satellite Strength .....	10
Saved Tracks .....	17
Setup Menu .....	41-47
Shallow Water Alarm .....	46
Simulator .....	8, 42
Specifications .....	48
Software Version.....	41
Speed Filter.....	44
Sun and Moon.....	40
System Info (Serial Number) .....	41
System Mode.....	42

## T

Temperature Settings.....	44
Text Setting .....	13
Tides .....	38
Time.....	10
Time, Daylight Savings Time .....	43
Time Format .....	43
Time Tab .....	43
Time Zone.....	43
Track Information Page .....	24

Track Back.....	24
Track Log .....	16
Trip Computer .....	21

## U

Units Tab.....	44
Universal Time Coordinate.....	50
WAAS .....	42
Warranty .....	65
Waypoints .....	25
Waypoint Options.....	25
Waypoints - Creating.....	26-29
Waypoints - Deleting.....	29
Waypoints - Editing.....	29
Waypoints - Proximity.....	
Wiring.....	49

## Z

Zoom Scale .....	12
Zoom Setting.....	13

## Appendix J

### Warranty

GARMIN International, Inc.  
1200 East 151st Street  
Olathe, Kansas 66062, U.S.A.  
Phone: 913/397.8200  
FAX: 913/397.0836

GARMIN (Europe) Ltd.  
Unit 4, The Quadrangle,  
Abbey Park Industrial Estate  
Romsey, SO51 9AQ, U.K.  
Phone: 44/1794.519944  
FAX: 44/1794.519222

### LIMITED WARRANTY

This GARMIN product is warranted to be free from defects in materials or workmanship for one year from the date of purchase. Within this period, GARMIN will at its sole option, repair or replace any components that fail in normal use. Such repairs or replacement will be made at no charge to the customer for parts or labor, provided that the customer shall be responsible for any transportation cost. This warranty does not cover failures due to abuse, misuse, accident or unauthorized alteration or repairs.

THE WARRANTIES AND REMEDIES CONTAINED HEREIN ARE EXCLUSIVE AND IN LIEU OF ALL OTHER WARRANTIES EXPRESS OR IMPLIED OR STATUTORY, INCLUDING ANY LIABILITY ARISING UNDER ANY WARRANTY OF MERCHANTABILITY OR FITNESS FOR A PARTICULAR PURPOSE, STATUTORY OR OTHERWISE. THIS WARRANTY GIVES YOU SPECIFIC LEGAL RIGHTS, WHICH MAY VARY FROM STATE TO STATE.

IN NO EVENT SHALL GARMIN BE LIABLE FOR ANY INCIDENTAL, SPECIAL, INDIRECT OR CONSEQUENTIAL DAMAGES, WHETHER RESULTING FROM THE USE, MISUSE, OR INABILITY TO USE THIS PRODUCT OR FROM DEFECTS IN THE PRODUCT. Some states do not allow the exclusion of incidental or consequential damages, so the above limitations may not apply to you.

GARMIN retains the exclusive right to repair or replace the unit or software or offer a full refund of the purchase price at its sole discretion. SUCH REMEDY SHALL BE YOUR SOLE AND EXCLUSIVE REMEDY FOR ANY BREACH OF WARRANTY.

To obtain warranty service, contact your local GARMIN authorized dealer. Or call GARMIN Customer Service at one of the numbers shown below, for shipping instructions and an RMA tracking number. The unit should be securely packed with the tracking number clearly written on the outside of the package. The unit should then be sent, freight charges prepaid, to any GARMIN warranty service station. A copy of the original sales receipt is required as the proof of purchase for warranty repairs.

Products sold through online auctions are not eligible for rebates or other special offers from GARMIN. Online auction confirmations are not accepted for warranty verification. To obtain warranty service, an original or copy of the sales receipt from the original retailer is required. GARMIN will not replace missing components from any package purchased through an online auction.

**For the latest free software updates throughout the life  
of your GARMIN products, visit the GARMIN web site at  
[www.garmin.com](http://www.garmin.com).**



© Copyright 2002 GARMIN Ltd. or its subsidiaries

GARMIN International, Inc.  
1200 East 151<sup>st</sup> Street, Olathe, Kansas 66062, U.S.A.

GARMIN (Europe) Ltd.  
Unit 5, The Quadrangle, Abbey Park Industrial Estate, Romsey, SO51 9AQ, U.K.

GARMIN Corporation  
No. 68, Jangshu 2<sup>nd</sup> Road, Shijr, Taipei County, Taiwan

[www.garmin.com](http://www.garmin.com)

Part Number 190-00294-00 Rev. B